

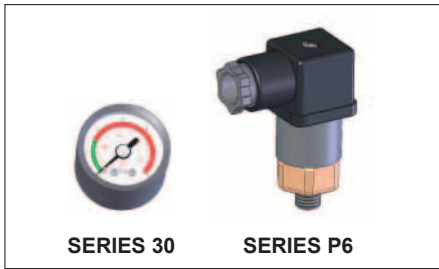

# TA-TB

COMBINED  
RETURN-SUCTION  
FILTER



### CLOGGING INDICATOR

A visual or electrical indicator is available as an option and allows to monitor the element condition. The port for the indicator is a standard feature.

CLOGGING INDICATOR

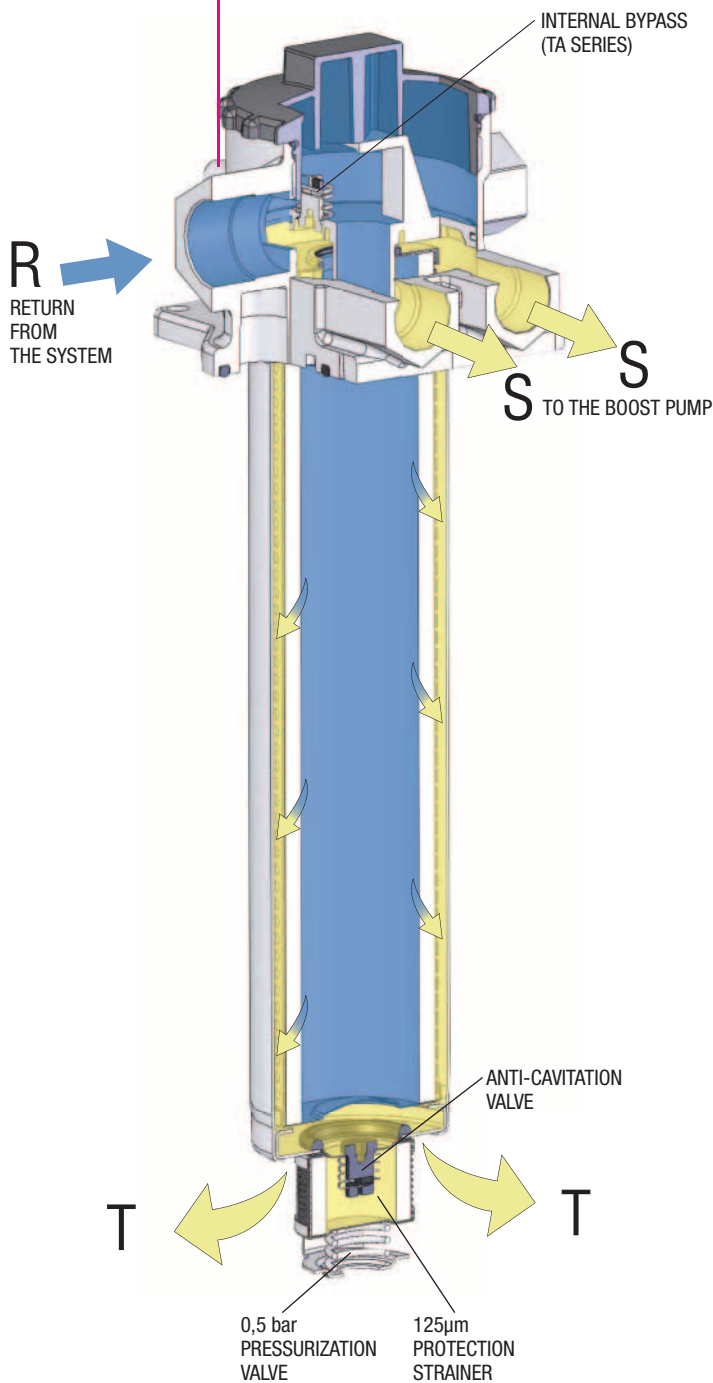

The **TA-TB** filters are designed to work in hydraulic systems combined with hydrostatic transmission, when the return flow is higher than the flow of the boost pump in any operating condition.

The oil from the return line of the system is filtered from the inside to the outside of the filter element and goes to the suction of the boost pump with a 0,5 bar pressurization. The exceeding flow rate goes into the reservoir.

A flow rate 50% higher than the flow required by the boost pump is recommended in normal operating conditions.

**TA** have an internal bypass system.  
**TB** have external bypass to the reservoir.

### ADVANTAGES

- One filter for two functions: filtering the oil returning from the hydraulic system and feeding the boost pump with cleanest oil
- Pressurization allows absolute filtration on the suction of the boost pump
- No cavitation risk
- Filter element working from inside to outside allows retained contamination to be completely removed when replacing the element

### FILTER ELEMENT

The filter element is manufactured with filter medias selected in the UFI laboratory and mechanically supported to maintain the highest performance even at high differential pressures.



COMBINED  
RETURN-SUCTION  
FILTER

# TA & TB



## MATERIALS

Head:  
Aluminium alloy

Cover:  
Polyamide TA-TB23  
Aluminium alloy TA-TB31-32-33

Bowl:  
Steel

Seals:  
NBR Nitrile

Indicator housing:  
Brass

## PRESSURE (ISO 10771-1:2002)

Max working: 1 MPa (10 bar)

Test: 1,5 MPa (15 bar)

Bursting: 3 MPa (30 bar)

Collapse, differential  
for the filter element: 1 MPa (10 bar)

## BYPASS VALVE

Setting:  
250 kPa (2,5 bar)  $\pm$  10%

## WORKING TEMPERATURE

From -25° to + 110° C

## COMPATIBILITY (ISO 2943:1999)

Full with fluids: HH-HL-HM-HV-HTG  
(according to ISO 6743/4)  
For fluids different than the above  
mentioned, please contact our Sales  
Department.

## APPLICATION EXAMPLE



**UFI**  
FILTERS  
HYDRAULIC  
DIVISION

**TA 23  
WITH INTERNAL BYPASS**

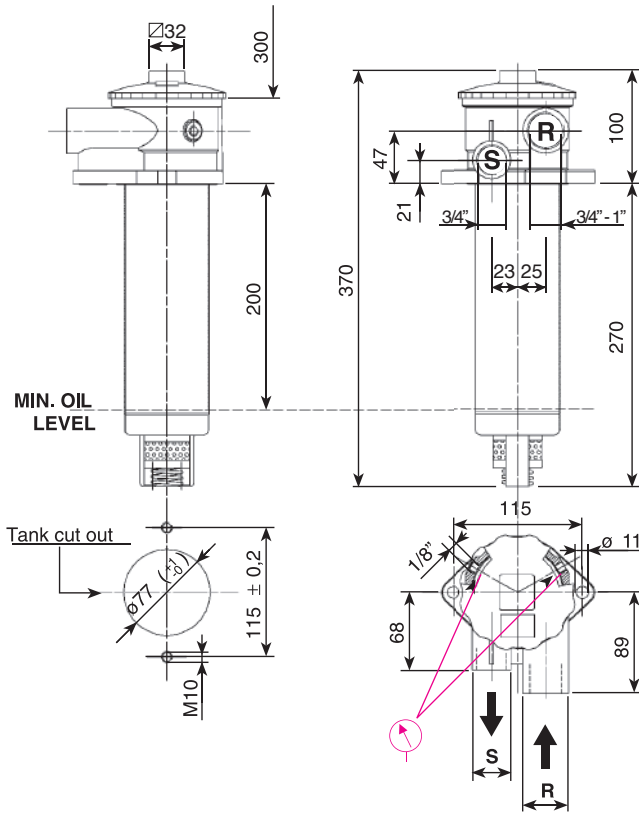

**TB 23  
WITH EXTERNAL BYPASS**

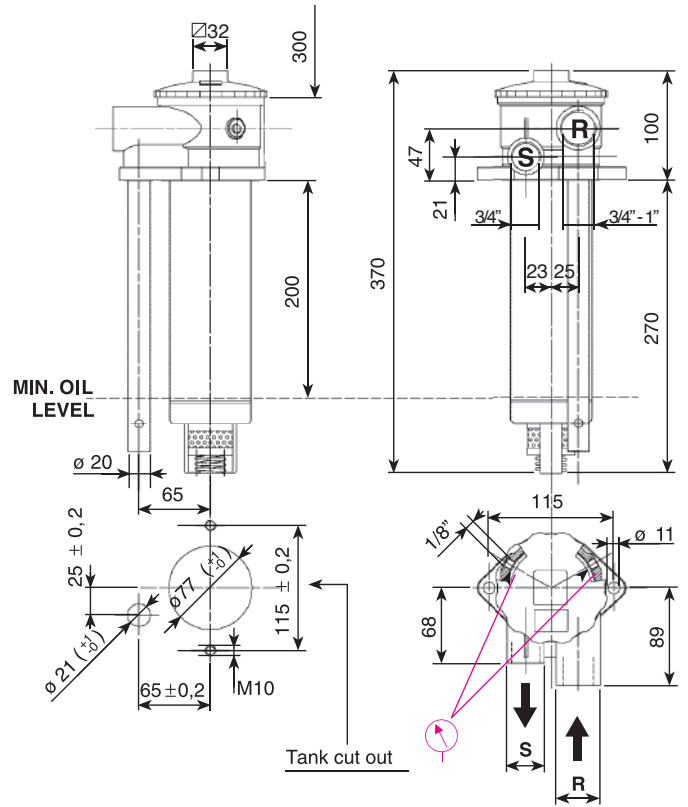

## WORKING SCHEME

**Options A and C**  
are recommended  
for horizontal filter mounting.

**Options B and D**  
are recommended  
for vertical filter mounting  
(drain hole).

**Options C and D**  
a 125 µm strainer protects the emergency  
valve in case of brief lack of oil in the suction  
of the boost pump (situation to be anyway  
avoided)

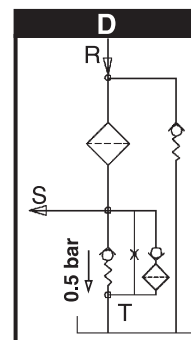
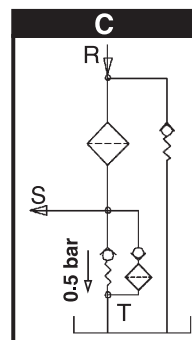
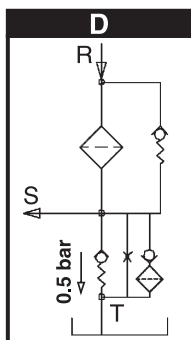
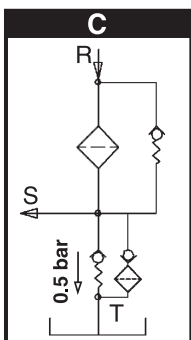
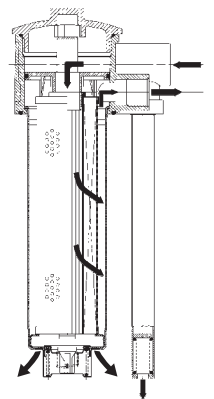
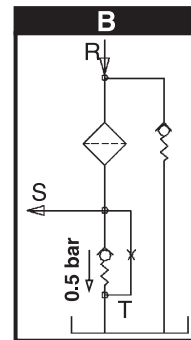
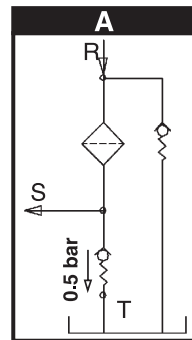
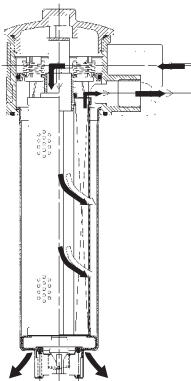
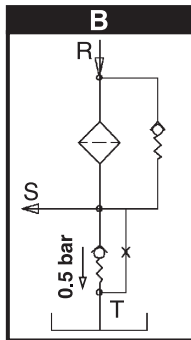
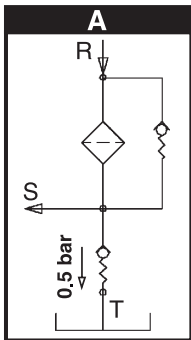

**TA 31-32-33  
WITH INTERNAL BYPASS**

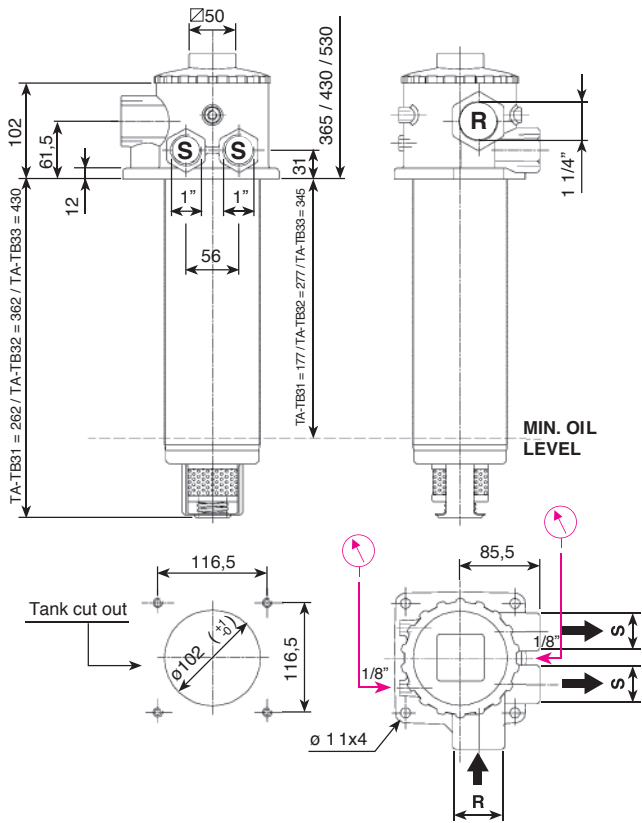

**TB 31-32-33  
WITH EXTERNAL BYPASS**

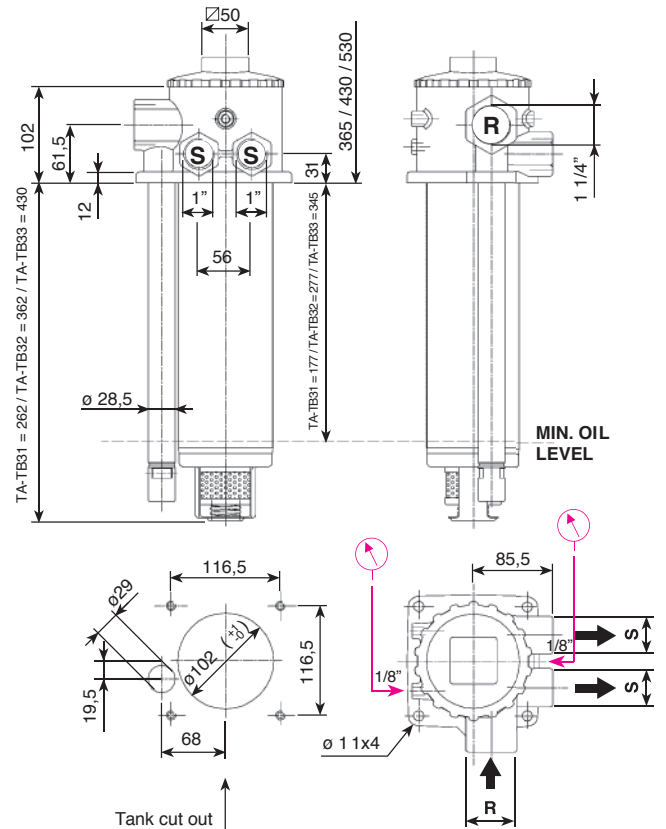

**WORKING SCHEME**

**Options A and C**  
are recommended  
for horizontal filter mounting.

**Options B and D**  
are recommended  
for vertical filter mounting  
(drain hole).

**Options C and D**  
a 125 µm strainer protects the emergency  
valve in case of brief lack of oil in the suction  
of the boost pump (situation to be anyway  
avoided)

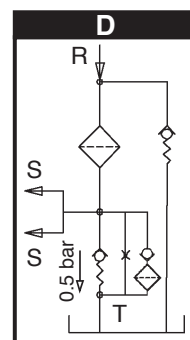
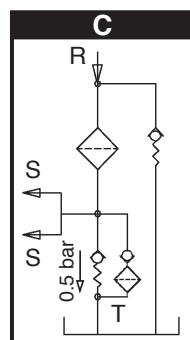
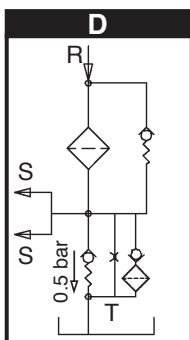
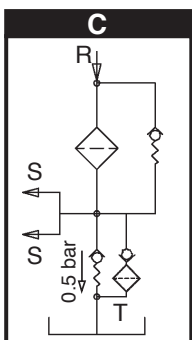
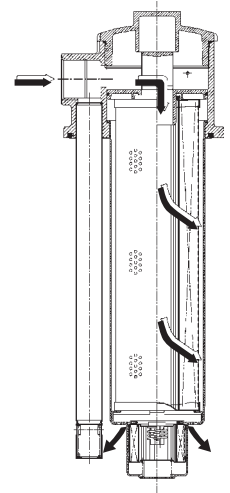
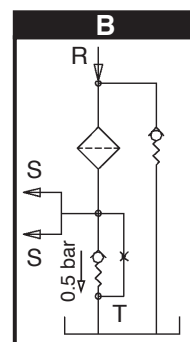
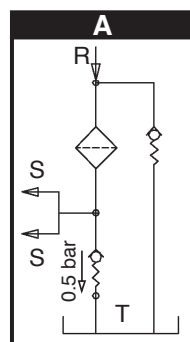
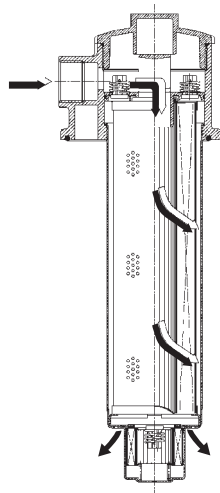
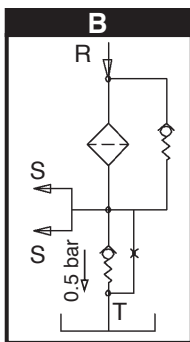
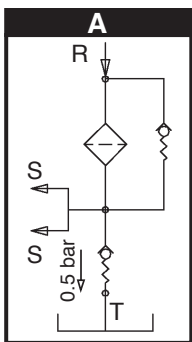

### FILTER HOUSING PRESSURE DROP

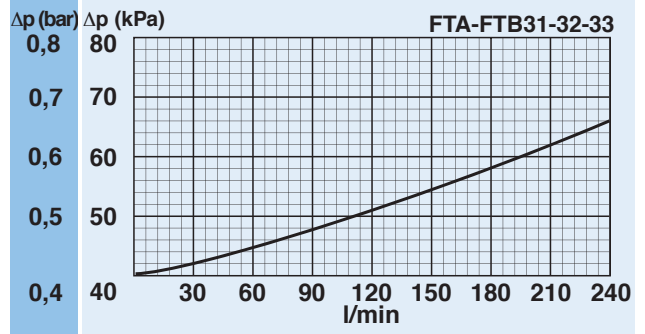
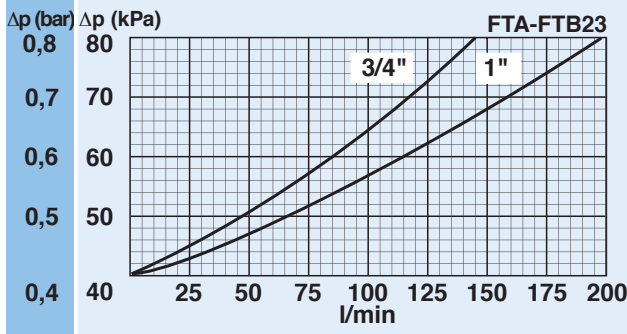

### CLEAN FILTER ELEMENT PRESSURE DROP

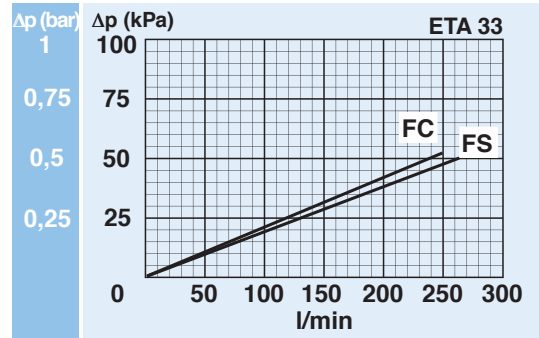
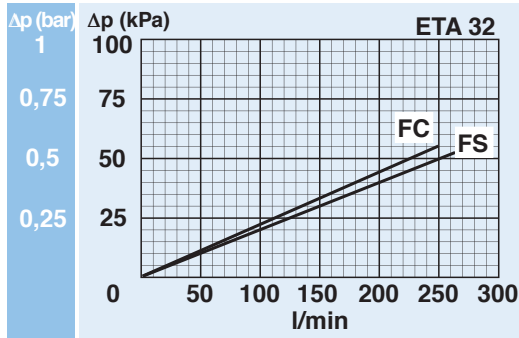
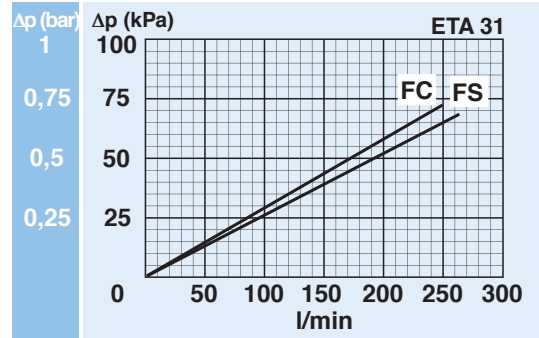
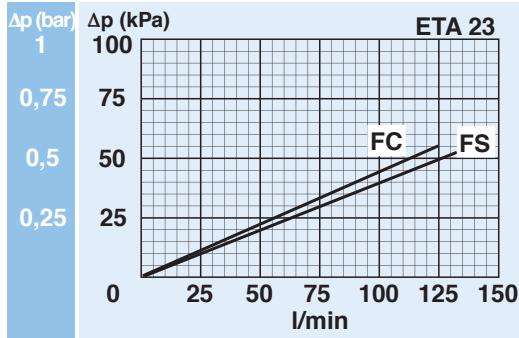

### BYPASS VALVE PRESSURE DROP

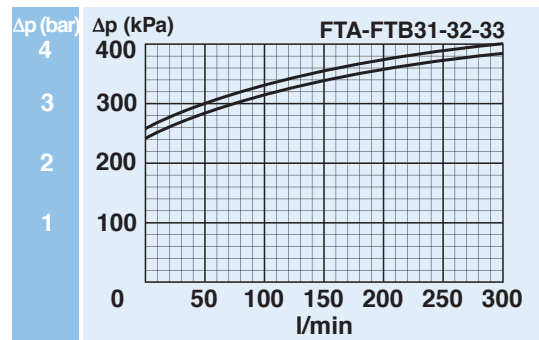
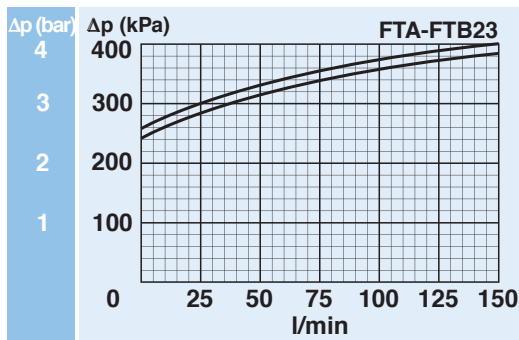

N.B. All the curves have been obtained with mineral oil having a kinematic viscosity 30 cSt and specific gravity 0,9 kg/dm<sup>3</sup>; for fluids with different features, please consider the factors described in the first part of this catalogue. All the curves are obtained from test done at the UFI HYDRAULIC DIVISION Laboratory, according to the specification ISO 3968:2005. In case of discrepancy, please check the contamination level, viscosity and features of the fluid in use.

### FILTER ELEMENT

	A	B	C	kg	Area (cm <sup>2</sup> ) Media F+
ETA23	63,5	28	230	0,40	1.900
ETA31	90	40	232	0,55	2.800
ETA32	90	40	333	0,77	4.100
ETA33	90	40	400	0,85	4.900

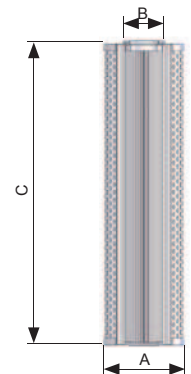

		<b>TYPE</b>					
		F = FILTER COMPLETE	F	F	F	F	
		B = FILTER HOUSING	B	B	B	B	
T		<b>FAMILY, NOMINAL SIZE &amp; LENGTH</b>				<b>ELEMENT</b> E	
		TA = with internal bypass	23	31	32	33	<b>FAMILY SIZE &amp; LENGTH</b> T A
	TB = with external bypass	23	31	32	33		
		<b>PORT TYPE</b>					
		B = BSP thread	B	B	B	B	
		<b>PORT SIZE</b>					
		D3 = 3/4" suction + 3/4" return	D3	-	-	-	
		D4 = 3/4" suction + 1" return	D4	-	-	-	
		T1 = 1 1/4" return + 2x1" suction	-	T1	T1	T1	
B		<b>BYPASS VALVE</b>					
		B = 250 kPa (2,5 bar) return	B	B	B	B	
N		<b>SEALS</b>				<b>SEALS</b> N	
		N = NBR Nitrile	N	N	N	N	<b>N = NBR</b>
		<b>FILTER MEDIA</b>				<b>FILTER MEDIA</b>	
		FC = fiber 12 $\mu\text{m}_{(c)}$ $\beta > 1.000$	FC	FC	FC	FC	FC = fiber 12 $\mu\text{m}_{(c)}$
		FS = fiber 16 $\mu\text{m}_{(c)}$ $\beta > 1.000$	FS	FS	FS	FS	FS = fiber 16 $\mu\text{m}_{(c)}$
		<b>CLOGGING INDICATORS</b>					
		05 = nr. 2 x 1/8" ports, plugged	05	05	05	05	
		30 = pressure gauge, rear connection	30	30	30	30	
		P6 = SPDT, pressure switch	P6	P6	P6	P6	
		<b>ACCESSORIES</b>					
		A = pressurisation valve	A	A	A	A	
		B = press. valve + drain hole	B	B	B	B	
		C = press. valve + suction bypass	C	C	C	C	
		D = press. valve + drain hole + suction bypass	D	D	D	D	
X		<b>ACCESSORIES</b>					
		X = no other accessory available	X	X	X	X	

SPARE PARTS ELEMENTS (For filling up see table "Ordering and option chart")

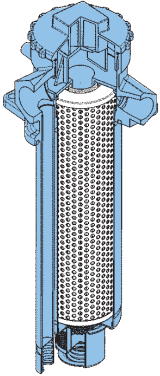
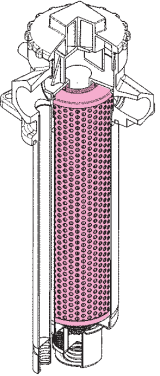
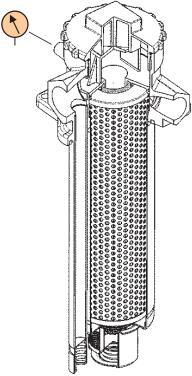
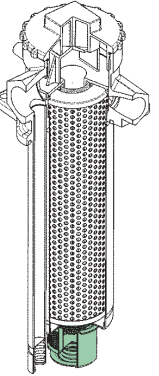
FILTER HOUSING	FILTER ELEMENT	CLOGGING INDICATOR	ACCESSORY
			
BT           BN         X	E   T   A     N		



Is this datasheet the latest release? Please check on our website.





UFI HYDRAULIC DIVISION  
Planet Filters S.p.A.  
via S.Chierico, 24 - 24060 Bolgare (BG)  
Tel. +39 035 4493831 - Fax +39 035 843743  
e-mail: [info@ufihyd.com](mailto:info@ufihyd.com) - [www.ufihyd.com](http://www.ufihyd.com)

COMPANY  
WITH QUALITY SYSTEM  
CERTIFIED BY DNV  
=ISO 9001/2000=

COMPANY WITH  
ENVIRONMENTAL MANAGEMENT  
SYSTEM CERTIFIED BY DNV  
=ISO 14001=

