

# PD



## MATERIALS

Head:  
Cast iron

Bowl:  
Steel

Seals:  
NBR Nitrile  
(FKM - on request fluoroelastomer)

Indicator housing:  
Brass

## PRESSURE (ISO 10771-1:2002)

Max. working: 31,5 MPa (315 bar)

Test: 47 MPa (470 bar)

Bursting: 95 MPa (950 bar)

Collapse, differential  
for the filter element (ISO 2941):  
21 MPa (210 bar)

## APPLICATION EXAMPLE



## WORKING TEMPERATURE

From -25° to + 110° C

## COMPATIBILITY (ISO 2943:1999)

Full with fluids: HH-HL-HM-HV-HTG  
(according to ISO 6743/4)  
For fluids different than the above  
mentioned, please contact our Sales  
Department.



**FPD 01 weight KG. 2,5**

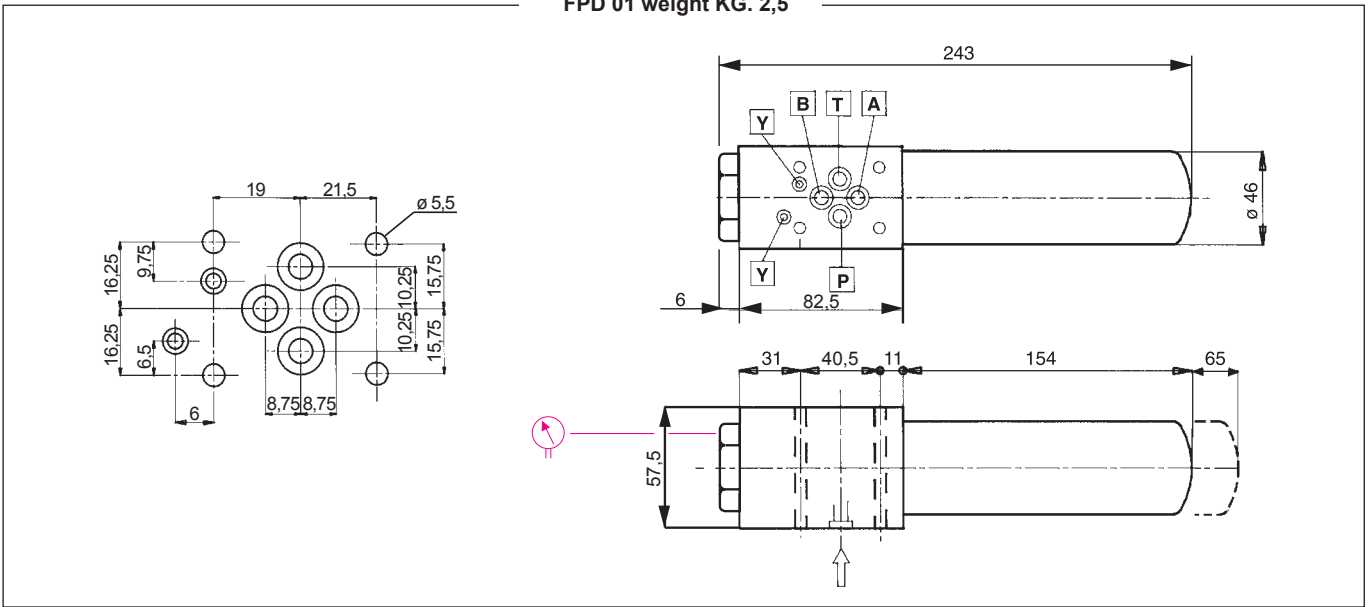

**FPD 02 weight KG. 2,5**

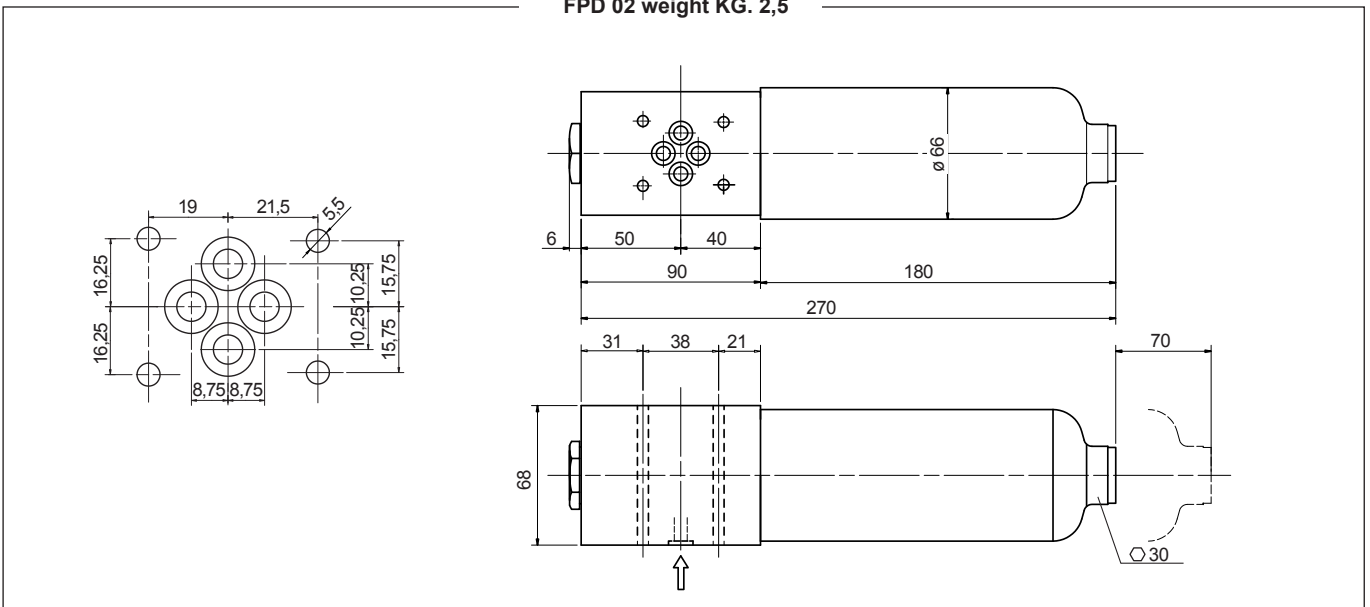

**FPD 12 weight KG. 4,2**

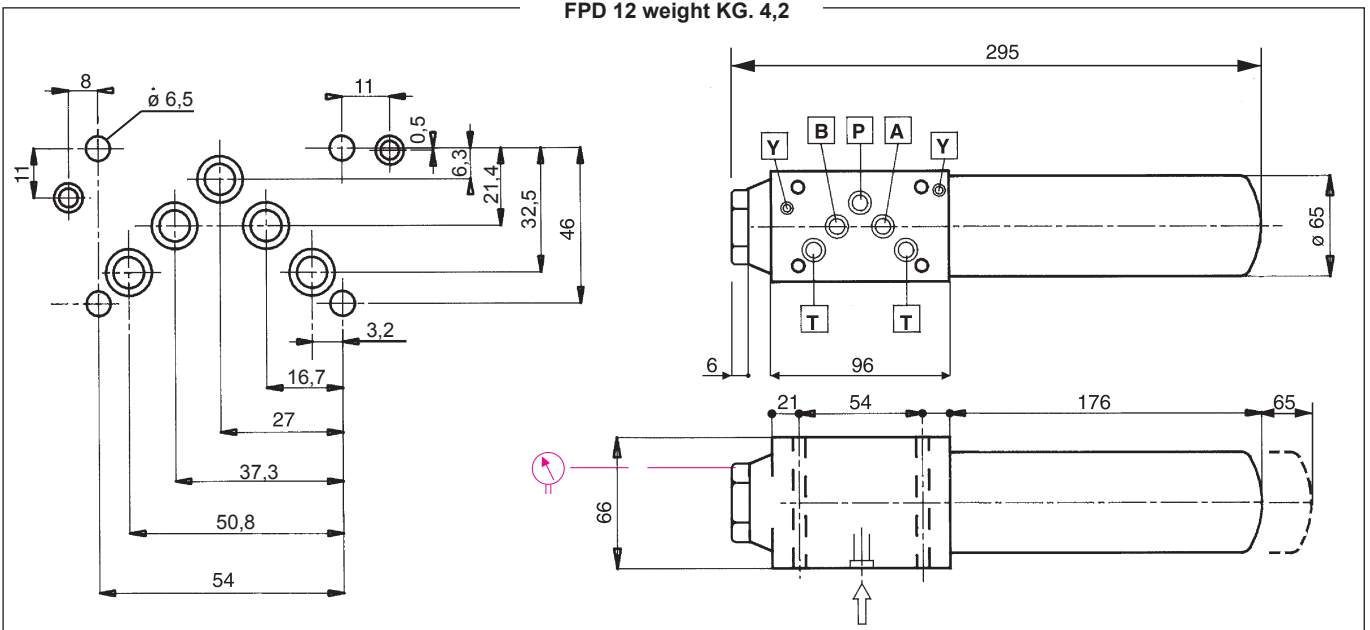

<b>TYPE</b>					
F = FILTER COMPLETE		F	F	F	
B = FILTER HOUSING		B	B	B	<b>ELEMENT</b> E
<b>P D</b>	<b>FAMILY,</b>	01	02	12	
	<b>NOMINAL SIZE &amp; LENGTH</b>	01	12	12	<b>FAMILY SIZE &amp; LENGTH</b> P B
<b>PORT TYPE</b>					
C = CETOP interface		C	C	C	
Y = bowl side B		Y	Y	-	
<b>PORT SIZE</b>					
03 = CETOP 3 (size 6)		03	03	-	
05 = CETOP 5 (size 10)		-	-	05	
<b>X</b>	<b>BYPASS VALVE</b>				
X = not available		X	X	X	
<b>SEALS</b>					<b>SEALS</b>
N = NBR Nitrile		N	N	N	N = NBR
F = FKM Fluoroelastomer		F	F	F	F = FKM
<b>FILTER MEDIA</b>					<b>FILTER MEDIA</b>
HA = fiber 5 $\mu\text{m}_{(e)}$ $\beta > 1.000 \Delta p_{21}$ MPa (210 bar)		HA	HA	HA	HA = fiber 5 $\mu\text{m}_{(e)}$
HB = fiber 7 $\mu\text{m}_{(e)}$ $\beta > 1.000 \Delta p_{21}$ MPa (210 bar)		HB	HB	HB	HB = fiber 7 $\mu\text{m}_{(e)}$
HC = fiber 12 $\mu\text{m}_{(e)}$ $\beta > 1.000 \Delta p_{21}$ MPa (210 bar)		HC	HC	HC	HC = fiber 12 $\mu\text{m}_{(e)}$
HD = fiber 21 $\mu\text{m}_{(e)}$ $\beta > 1.000 \Delta p_{21}$ MPa (210 bar)		HD	HD	HD	HD = fiber 21 $\mu\text{m}_{(e)}$
<b>CLOGGING INDICATOR</b>					
03 = port, plugged		03	03	03	When the filter is ordered with FKM seals, the first digit of the indicator code is a letter (please see page 182 - 183).
5F = visual differential 800 kPa (8 bar)		5F	5F	5F	
6F = electrical differential 800 kPa (8 bar)		6F	6F	6F	
7F = indicator 6F with LED		7F	7F	7F	
T3 = elect. diff. 800 kPa (8 bar) with thermostat 30°C		T3	T3	T3	
<b>X X</b>	<b>ACCESSORIES</b>				<b>N.B.</b> Indicator series 73 only on request
XX = no accessory available		XX	XX	XX	

**FILTER ELEMENT**

	A	B	C	kg	Area (cm <sup>2</sup> ) Media H+
EPB01	16	33	100	0,14	270
EPB12	25	45	115	0,55	475

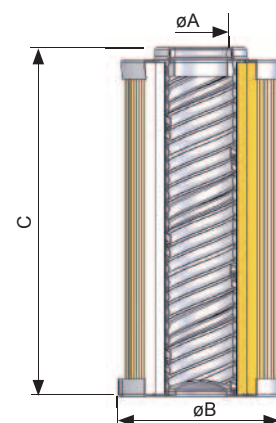

FPD 21 weight KG. 4 - FPD 22 weight KG. 5,5

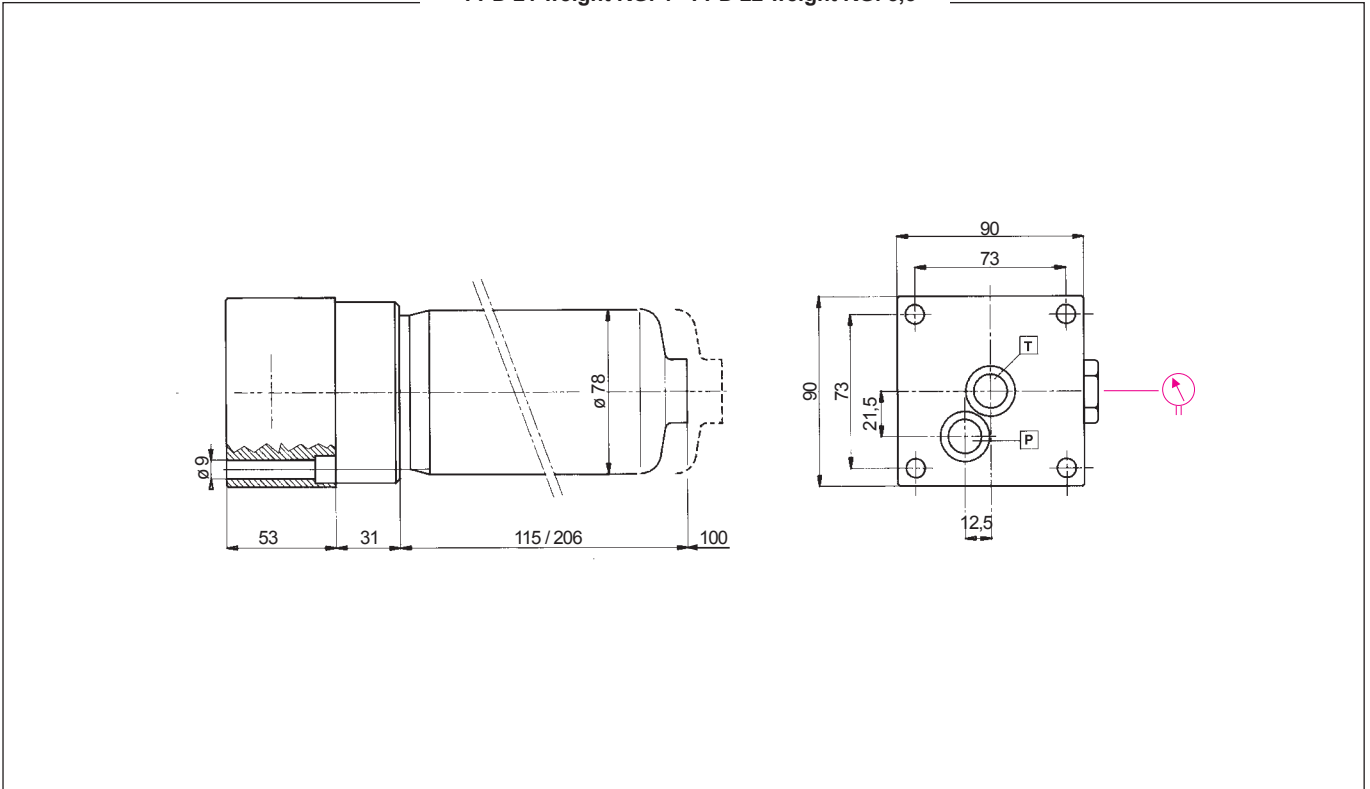

FPD 31 - 32 - 33 - 34

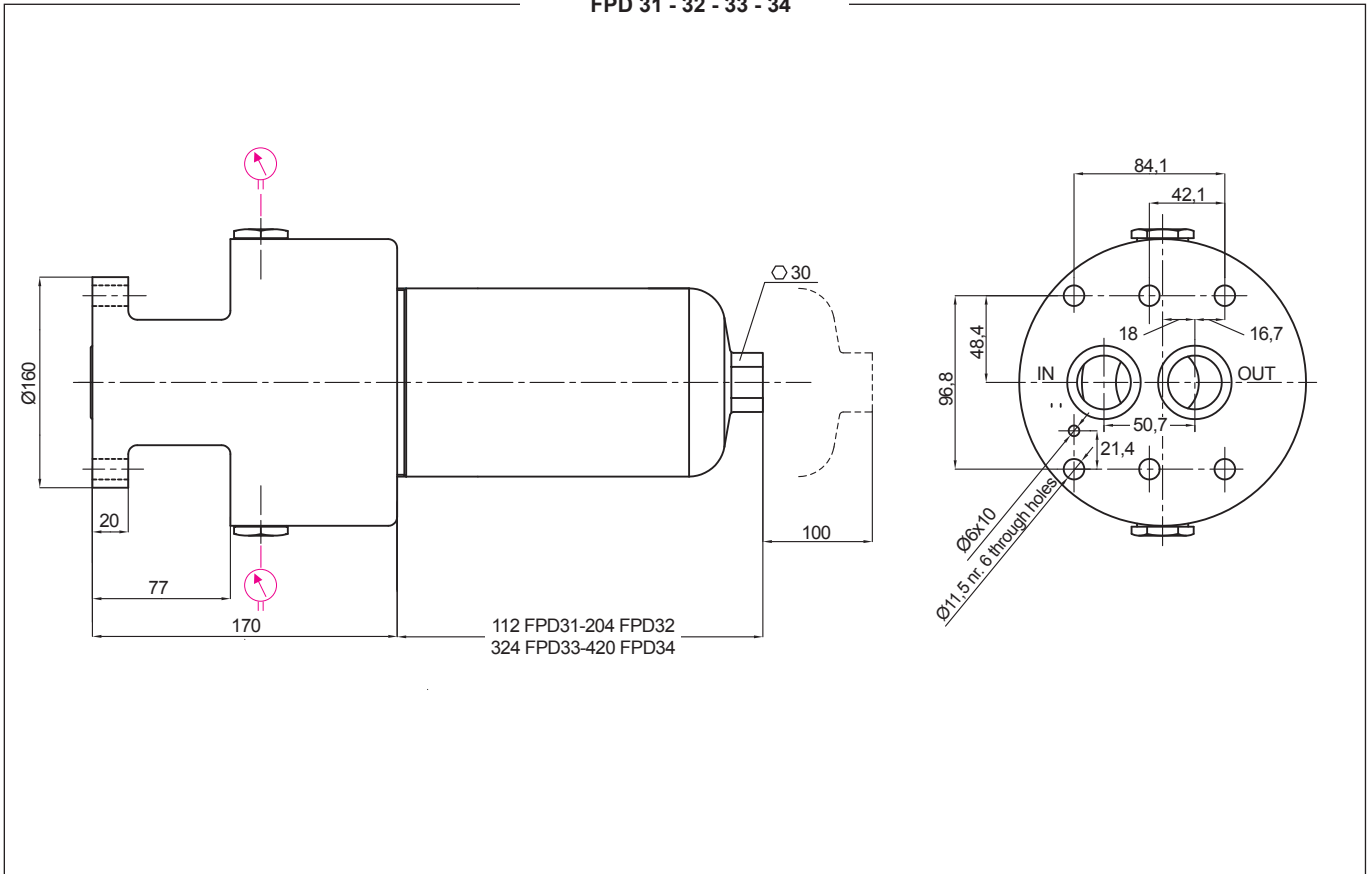

	<b>TYPE</b>								
	F = FILTER COMPLETE	F	F	F	F	F	F		
	B = FILTER HOUSING	B	B	B	B	B	B	<b>ELEMENT</b>	E
<b>P D</b>	<b>FAMILY NOMINAL SIZE &amp; LENGTH</b>							<b>FAMILY SIZE &amp; LENGTH</b>	P B
		21	22	31	32	33	34		
<b>C</b>	<b>PORT TYPE</b>								
	C = CETOP interface	C	C	C	C	C	C		
	<b>PORT SIZE</b>								
	07 = CETOP 7 size 16	07	07	-	-	-	-		
	30 = SIZE 30	-	-	30	30	30	30		
<b>X</b>	<b>BYPASS VALVE</b>								
	X = not available	X	X	X	X	X	X		
	<b>SEALS</b>							<b>SEALS</b>	
	N = NBR Nitrile	N	N	N	N	N	N	N = NBR	
	F = FKM Fluoroelastomer	F	F	F	F	F	F	F = FKM	
	<b>FILTER MEDIA</b>							<b>FILTER MEDIA</b>	
	HA = fiber 5 μm <sub>(e)</sub> β > 1.000 Δp 21 MPa (210 bar)	HA	HA	HA	HA	HA	HA	HA = fiber 5 μm <sub>(e)</sub>	
	HB = fiber 7 μm <sub>(e)</sub> β > 1.000 Δp 21 MPa (210 bar)	HB	HB	HB	HB	HB	HB	HB = fiber 7 μm <sub>(e)</sub>	
	HC = fiber 12 μm <sub>(e)</sub> β > 1.000 Δp 21 MPa (210 bar)	HC	HC	HC	HC	HC	HC	HC = fiber 12 μm <sub>(e)</sub>	
	HD = fiber 21 μm <sub>(e)</sub> β > 1.000 Δp 21 MPa (210 bar)	HD	HD	HD	HD	HD	HD	HD = fiber 21 μm <sub>(e)</sub>	
	<b>CLOGGING INDICATOR</b>								
	03 = port, plugged	03	03	03	03	03	03	When the filter is ordered with FKM seals, the first digit of the indicator code is a letter (please see page 182 - 183).	
	5F = visual differential 800 kPa (8 bar)	5F	5F	5F	5F	5F	5F		
	6F = electrical differential 800 kPa (8 bar)	6F	6F	6F	6F	6F	6F		
	7F = indicator 6F with LED	7F	7F	7F	7F	7F	7F		
	T3 = elect. diff. 800 kPa (8 bar) with thermostat 30°C	T3	T3	T3	T3	T3	T3	N.B. Indicator series 73 only on request	
<b>X X</b>	<b>ACCESSORIES</b>								
	XX = no accessory available	XX	XX	XX	XX	XX	XX		

**FILTER ELEMENT**

	A	B	C	kg	Area (cm <sup>2</sup> ) Media H+
EPB21	23,5	52	115	0,40	975
EPB22	23,5	52	210	0,55	1.785
EPB31	42,5	78	118	0,70	1.470
EPB32	42,5	78	210	1,30	2.695
EPB33	42,5	78	330	1,60	4.325
EPB34	42,5	78	430	1,80	5.685

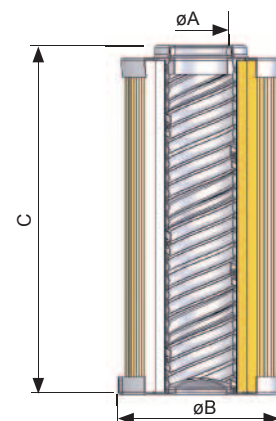

### FLUID SPEED

when selecting the filter size, we suggest to consider also the max recommended fluid speed (in pressure lines normally  $5 < v < 10$  m/s).

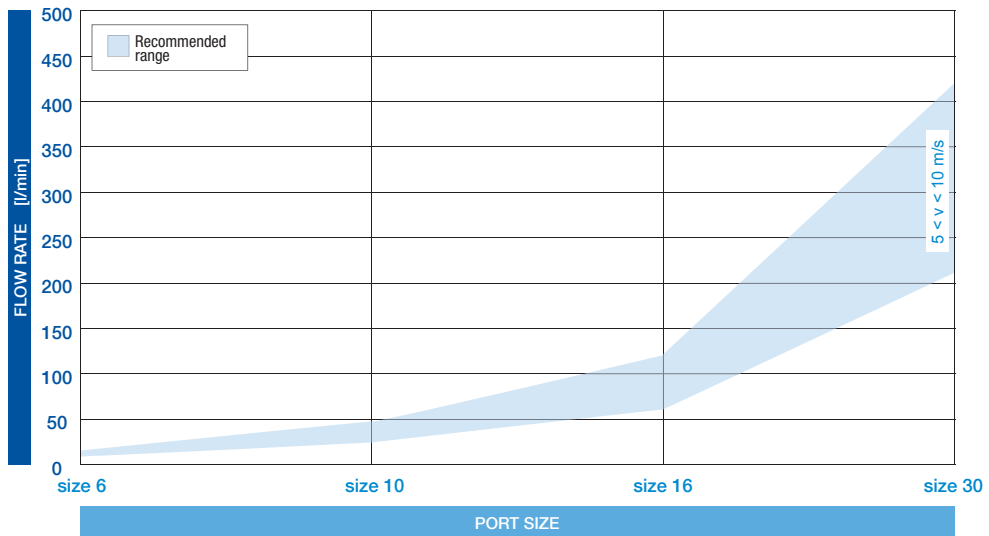

### PRESSURE DROP CURVES ( $\Delta p$ )

The "Assembly Pressure Drop ( $\Delta p$ )" is obtained by adding the pressure drop values of the Filter Housing and of the Clean Filter Element corresponding to the considered Flow Rate and it must be lower than 120 kPa (1,2 bar).

#### FILTER HOUSING PRESSURE DROP (mainly depending on the port size)

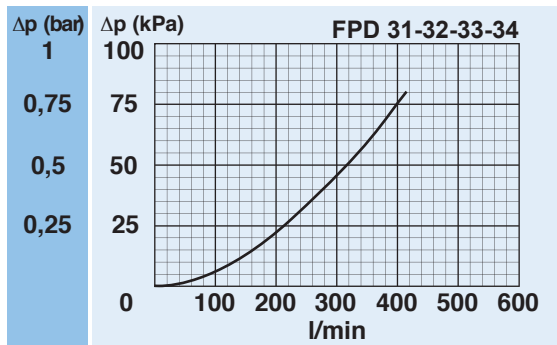
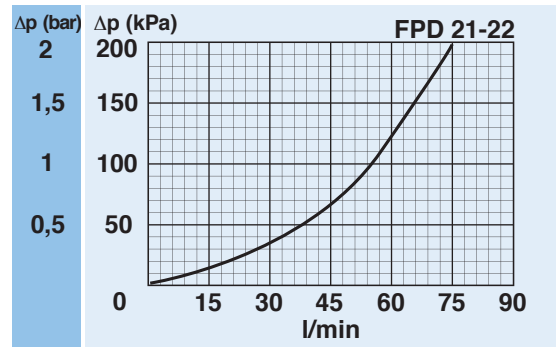
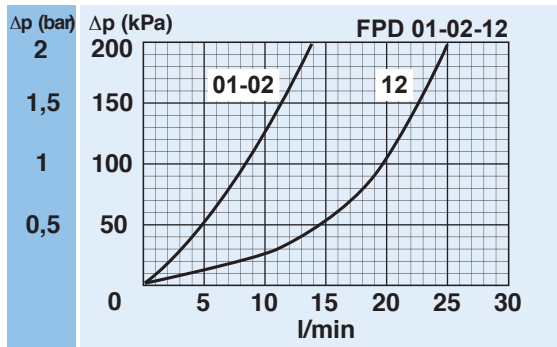

N.B. All the curves have been obtained with mineral oil having a kinematic viscosity 30 cSt and specific gravity 0,9 kg/dm<sup>3</sup>; for fluids with different features, please consider the factors described in the first part of this catalogue. All the curves are obtained from test done at the UFI HYDRAULIC DIVISION Laboratory, according to the specification ISO 3968:2005. In case of discrepancy, please check the contamination level, viscosity and features of the fluid in use.

**CLEAN FILTER ELEMENT PRESSURE DROP WITH H+ MEDIA**  
 (depending both on the internal diameter of the element and on the filter media)

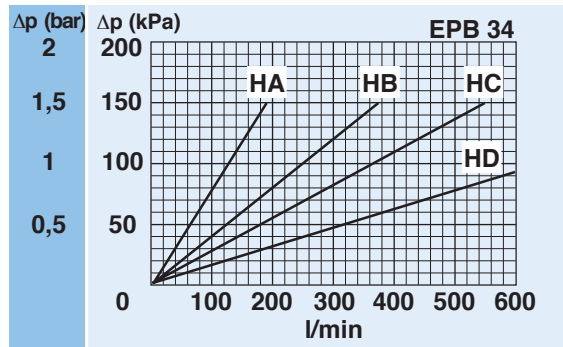
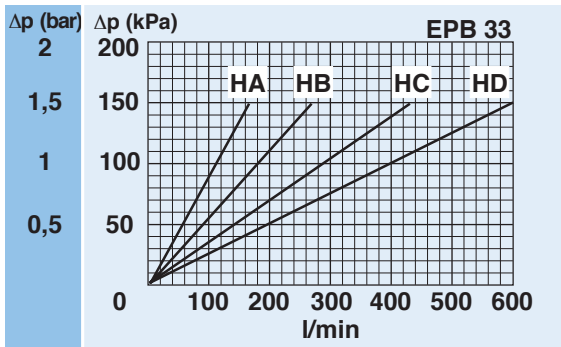
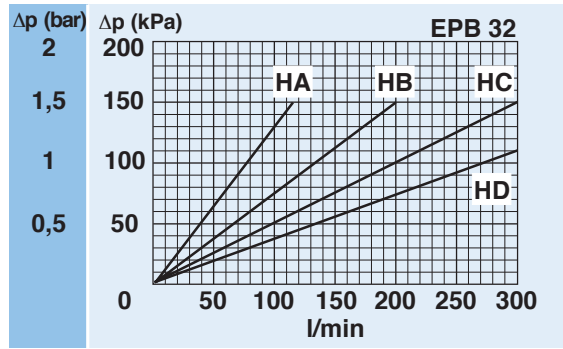
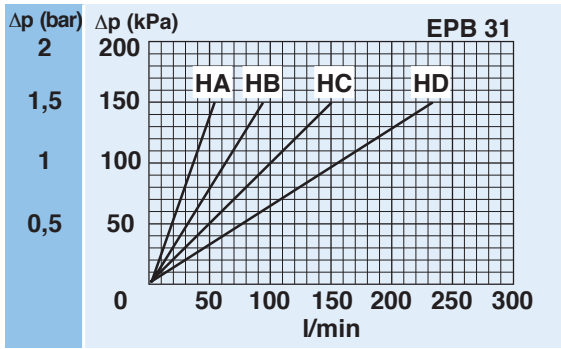
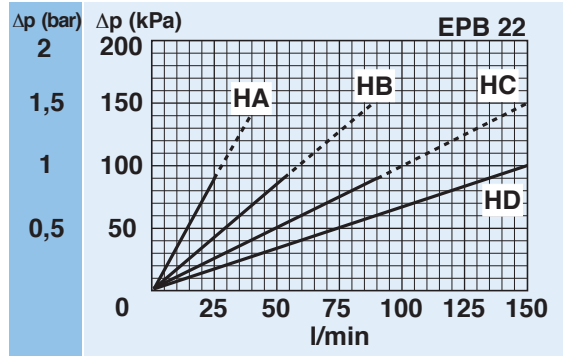
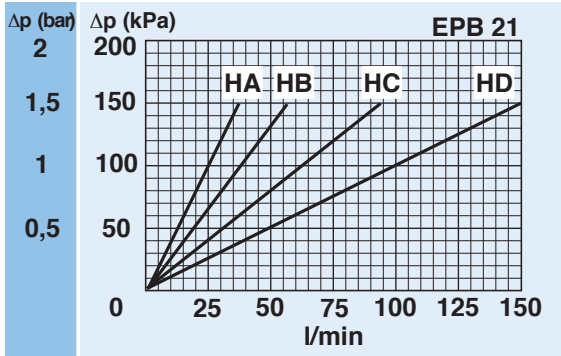
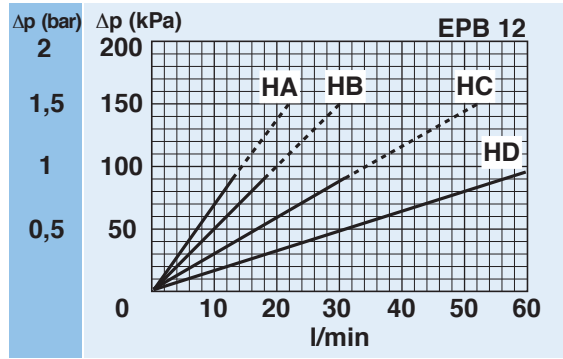
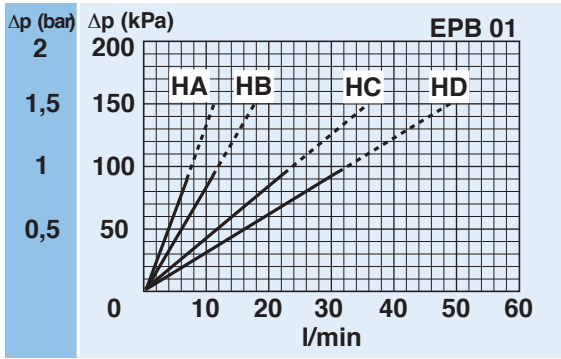

N.B. All the curves have been obtained with mineral oil having a kinematic viscosity 30 cSt and specific gravity 0,9 kg/dm<sup>3</sup>; for fluids with different features, please consider the factors described in the first part of this catalogue. All the curves are obtained from test done at the UFI HYDRAULIC DIVISION Laboratory, according to the specification ISO 3968:2005. In case of discrepancy, please check the contamination level, viscosity and features of the fluid in use.

## CLOGGING INDICATOR

A visual or visual-electrical differential indicator is available as an option and allows monitoring of the element conditions, giving an exact indication of the right time to replace the element.

## FILTER HOUSING

The head by high performance cast iron and the bowl by extruded steel ensure the best fatigue resistance to the working pressures.

## FILTER ELEMENT

The filter element is manufactured with filter medias selected in the UFI laboratory and mechanically supported to maintain the highest performances even at high differential pressures.

## SEAL GUARANTEED

A perfect O-ring seal is always ensured as it is not dependent on the tightening torque applied to the bowl.

## EASY ASSEMBLING

The CETOP head allows for modular assembly that is compact and leak free.

## CLOGGING INDICATOR

For further technical informations and other options see page 182-183.



Differential

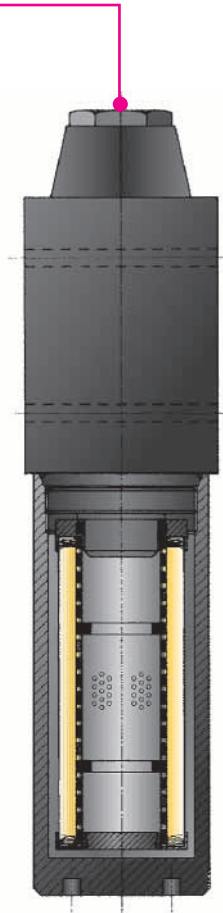

## SPARE SEAL KIT

	NBR	FKM
FPD01	521.0005.2	521.0073.2
FPD02	521.0107.2	521.0108.2
FPD12	521.0071.2	521.0074.2
FPD21	521.0072.2	521.0028.2
FPD22	521.0072.2	521.0028.2
FPD31	521.0109.2	521.0110.2
FPD32	521.0109.2	521.0110.2
FPD33	521.0109.2	521.0110.2
FPD34	521.0109.2	521.0110.2

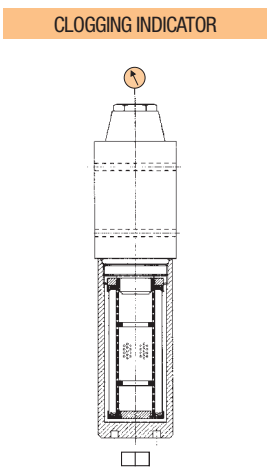
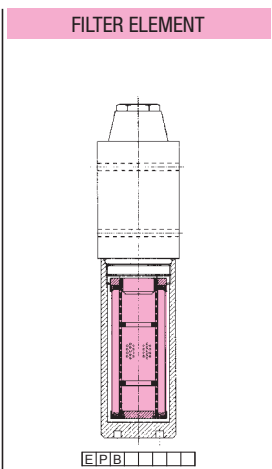
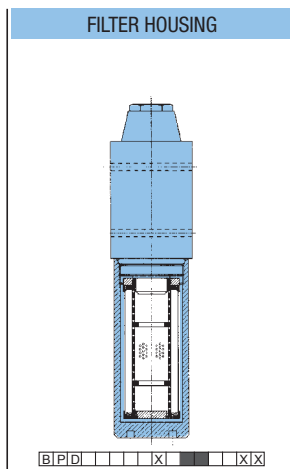

## SPARE PARTS ELEMENTS

(For filling up see table "Ordering and option chart")



Is this datasheet the latest release? Please check on our website.

