

# PC



## MATERIALS

Head:  
Cast iron

Bowl:  
Steel

Bypass valve:  
NBR Nitrile  
(FKM - on request fluoroelastomer)

Seals:  
NBR Nitrile  
(FKM - on request fluoroelastomer)

Indicator housing:  
Brass

## PRESSURE (ISO 10771-1:2002)

Max. working: 31,5 MPa (315 bar)

Test: 47 MPa (470 bar)

Bursting: 95 MPa (950 bar)

Collapse, differential  
for the filter element (ISO 2941):  
series standard 2 MPa (20 bar)  
serie H+ 21 MPa (210 bar)

## BYPASS VALVE

Setting:  
600 kPa (6 bar)  $\pm$  10%

## WORKING TEMPERATURE

From -25° to +110° C

## COMPATIBILITY (ISO 2943:1999)

Full with fluids: HH-HL-HM-HV-HTG  
(according to ISO 6743/4)  
For fluids different than the above  
mentioned, please contact our Sales  
Department.

## APPLICATION EXAMPLE

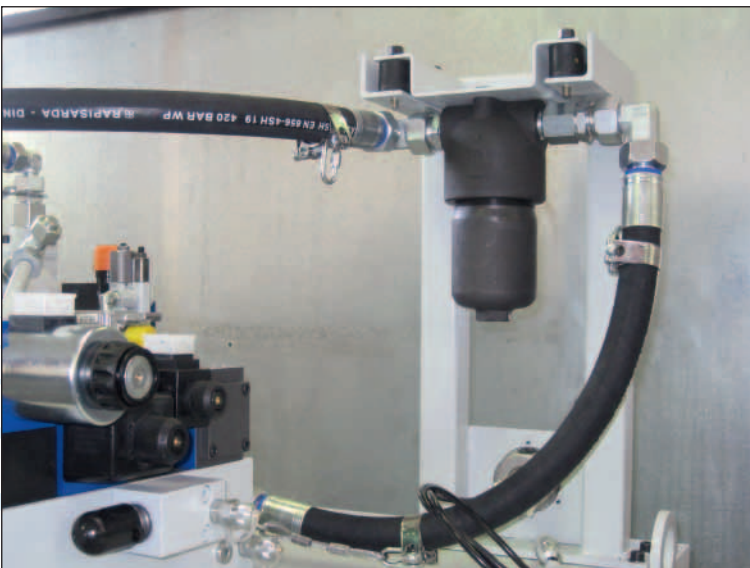

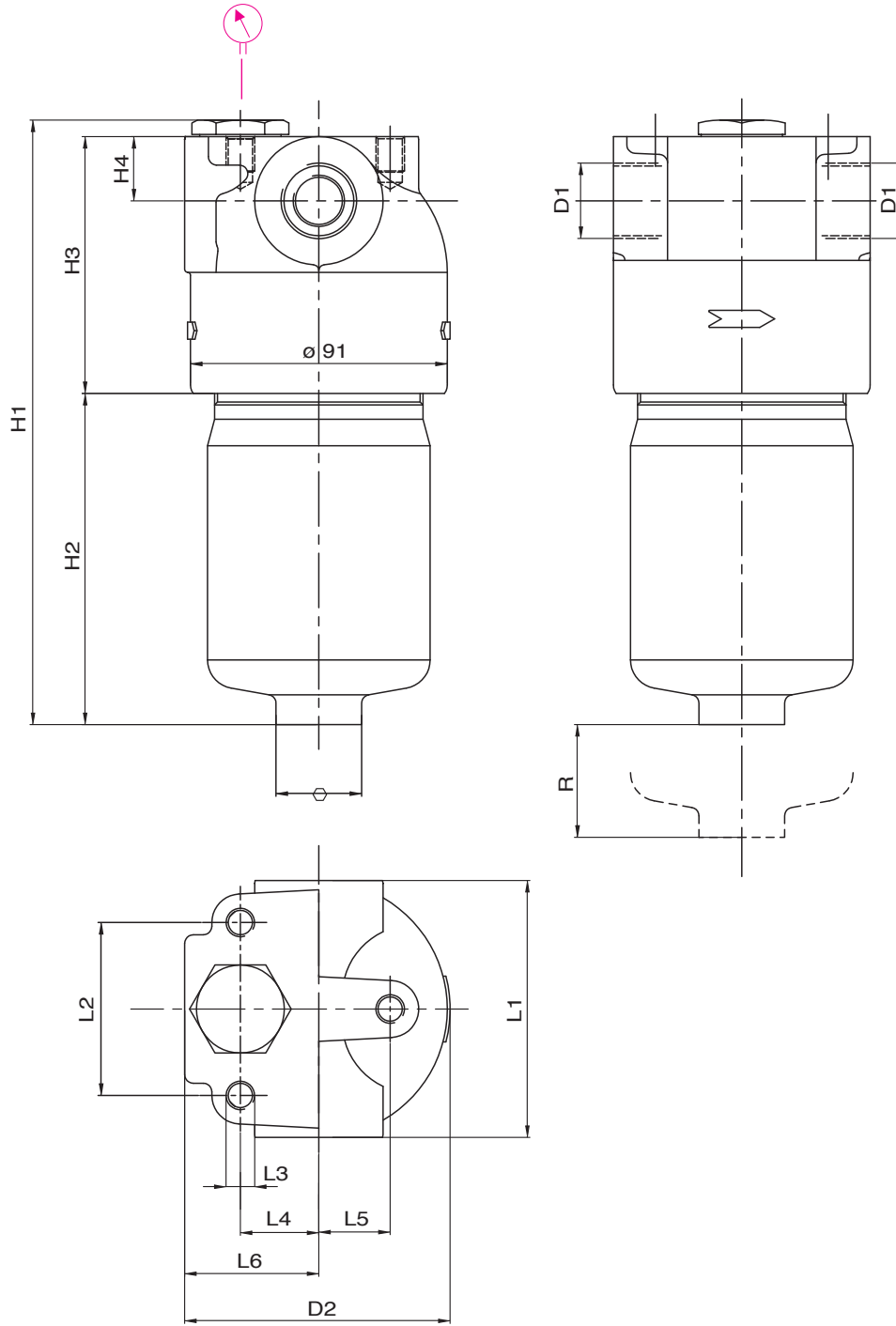

FILTER HOUSING													
	D1	D2	H1	H2	H3	H4	L1	L2	L3	L4	L5	R	kg
FPC21	1/2" - 3/4" - 1"	93	214	116	90	22,5	90	60,6	M10	27,5	25	100	4,3
FPC22	1/2" - 3/4" - 1"	93	305	207	90	22,5	90	60,6	M11	27,5	25	100	5,9

<b>TYPE</b>				
F = FILTER COMPLETE		F	F	
B = FILTER HOUSING		B	B	<b>ELEMENT</b> E
<b>P</b>	<b>C</b>	<b>FAMILY, SIZE &amp; LENGTH</b>		<b>P</b> <b>B</b>
		21	22	
<b>B</b>	<b>PORT TYPE</b>			
	B = BSP - thread	B	B	
	<b>PORT SIZE</b>			
	04 = 1/2"	04	04	
	06 = 3/4"	06	06	
	08 = 1"	08	08	
	<b>BYPASS VALVE</b>			
	W = without	W	W	
	C = 600 kPa (6 bar)	C	C	
	<b>SEALS</b>			<b>SEALS</b>
	N = NBR Nitrile	N	N	N = NBR
	F = FKM Fluoroelastomer	F	F	F = FKM
	<b>FILTER MEDIA</b>			<b>FILTER MEDIA</b>
	FA = fiber 5 μm <sub>e</sub> β>1.000 Δp 2MPa (20 bar)	FA	FA	FA = fib. 5μm <sub>e</sub> 20 bar
	FB = fiber 7 μm <sub>e</sub> β>1.000 Δp 2MPa (20 bar)	FB	FB	FB = fib. 7μm <sub>e</sub> 20 bar
	FC = fiber 12 μm <sub>e</sub> β>1.000 Δp 2MPa (20 bar)	FC	FC	FC = fib. 12μm <sub>e</sub> 20 bar
	FD = fiber 21 μm <sub>e</sub> β>1.000 Δp 2MPa (20 bar)	FD	FD	FD = fib. 21μm <sub>e</sub> 20 bar
	HA = fiber 5 μm <sub>e</sub> β>1.000 Δp 21MPa (210 bar)	HA	HA	HA = fib. 5μm <sub>e</sub> 210 bar
	HB = fiber 7 μm <sub>e</sub> β>1.000 Δp 21MPa (210 bar)	HB	HB	HB = fib. 7μm <sub>e</sub> 210 bar
	HC = fiber 12 μm <sub>e</sub> β>1.000 Δp 21MPa (210 bar)	HC	HC	HC = fib. 12μm <sub>e</sub> 210 bar
	HD = fiber 21 μm <sub>e</sub> β>1.000 Δp 21MPa (210 bar)	HD	HD	HD = fib. 21 μm <sub>e</sub> 210 bar
	CC = cellulose 10 μm β>2 Δp 2MPa (20 bar)	CC	CC	CC = cel. 10 μm 20 bar
	<b>CLOGGING INDICATORS</b>			
	03 = port, plugged	03	03	When the filter is ordered with FKM seals, the first digit of the indicator code is a letter (please see page 182 - 183).
	5E = visual differential 500 kPa (5 bar)	5E	5E	
	5F = visual differential 800 kPa (8 bar)	5F	5F	
	6E = electrical differential 500 kPa (5 bar)	6E	6E	
	6F = electrical differential 800 kPa (8 bar)	6F	6F	
	7E = indicator 6E with LED	7E	7E	
	7F = indicator 6F with LED	7F	7F	
	T2 = elect. diff. 500 kPa (5 bar) with thermostat 30°C	T2	T2	
	T3 = elect. diff. 800 kPa (8 bar) with thermostat 30°C	T3	T3	
	<b>ACCESSORIES</b>			
<b>X</b>	<b>X</b>	XX = no accessory available	XX	XX

**FILTER ELEMENT**

	A	B	C	kg media F+&C+	kg media H+	Area (cm <sup>2</sup> )		
						Media F+	Media H+	Media C+
EPB21	52	23,5	115	0,25	0,40	975	975	780
EPB22	52	23,5	210	0,35	0,55	1.830	1.785	1.465

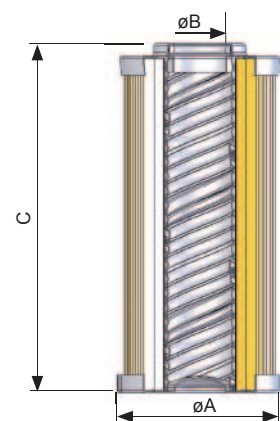

**FLUID SPEED**

when selecting the filter size, we suggest to consider also the max recommended fluid speed (in pressure lines normally  $5 < v < 10$  m/s).

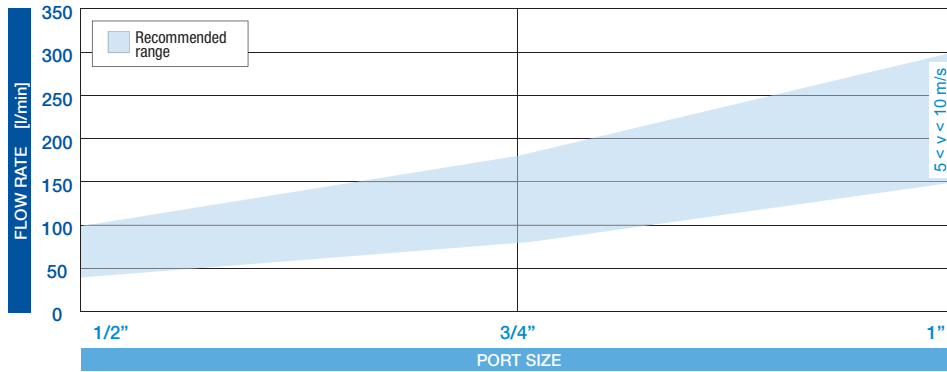

**PRESSURE DROP CURVES ( $\Delta p$ )**

The “Assembly Pressure Drop ( $\Delta p$ )” is obtained by adding the pressure drop values of the Filter Housing and of the Clean Filter Element corresponding to the considered Flow Rate and it must be lower than 120 kPa (1,2 bar).

**FILTER HOUSING PRESSURE DROP**  
(mainly depending on the port size)

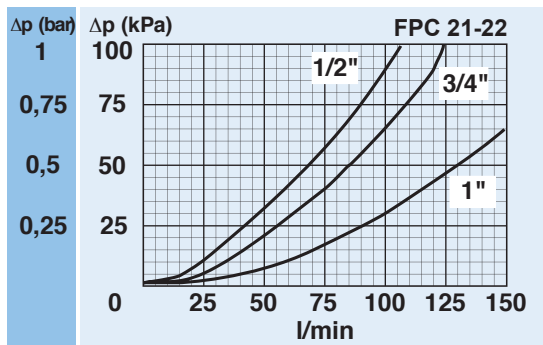

**CLEAN FILTER ELEMENT PRESSURE DROP WITH F+ AND C+ MEDIA**  
(depending both on the internal diameter of the element and on the filter media)

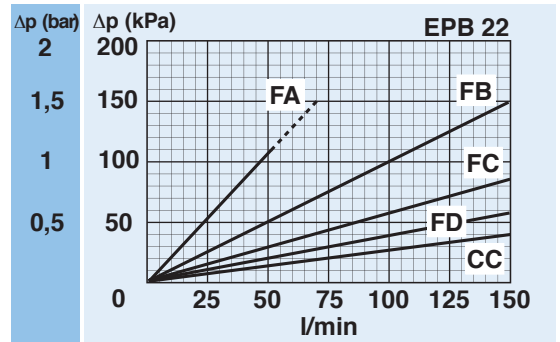
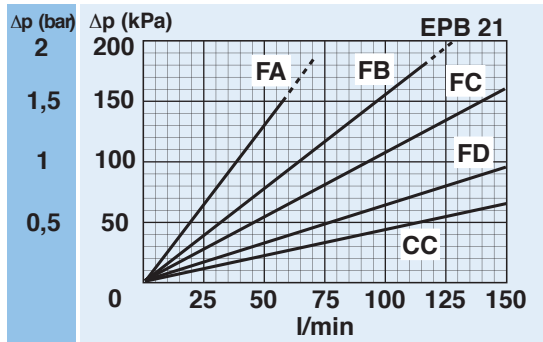

**CLEAN FILTER ELEMENT PRESSURE DROP**  
(depending both on the internal diameter of the element and on the filter media)

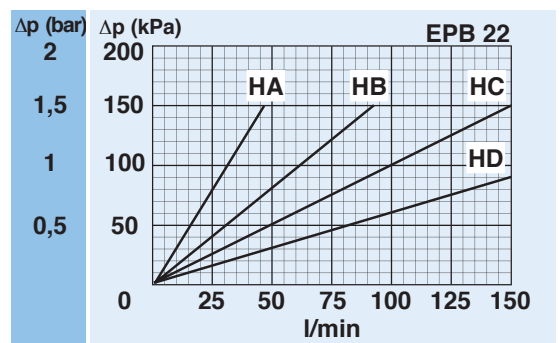
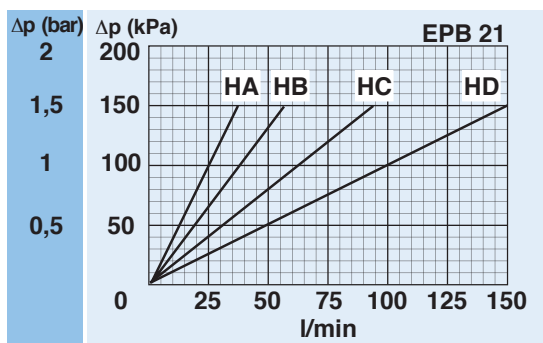

**WITH H+ MEDIA**  
(recommended with no bypass option)

**BYPASS VALVE PRESSURE DROP**

When selecting the filter size, these curves must be taken into account if it is foreseen that any flow peak is to be absorbed by the bypass valve, it also must be of proper configuration to avoid pressure peaks. The valve pressure drop is directly proportional to fluid specific gravity.

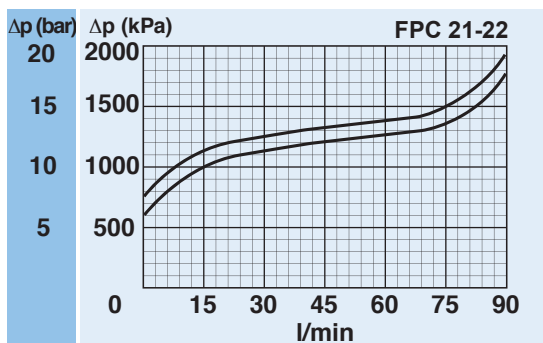

N.B. All the curves have been obtained with mineral oil having a kinematic viscosity 30 cSt and specific gravity 0,9 kg/dm<sup>3</sup>; for fluids with different features, please consider the factors described in the first part of this catalogue. All the curves are obtained from test done at the UFI HYDRAULIC DIVISION Laboratory, according to the specification ISO 3968:2005. In case of discrepancy, please check the contamination level, viscosity and features of the fluid in use.

**CLOGGING INDICATOR**

A visual or visual-electrical differential indicator is available as an option and allows monitoring of the element conditions, giving an exact indication of the right time to replace the element.

**FILTER HOUSING**

Head and bowl are made by high performance aluminium alloy ensuring the best fatigue resistance.

**FILTER ELEMENT**

The filter element is manufactured with filter medias selected in the UFI laboratory and mechanically supported to maintain the highest performance even at high differential pressures.

**SEAL GUARANTEED**

A perfect O-ring seal is always ensured as it is not dependent on the tightening torque applied to the bowl.

**EASY MAINTENANCE**

The hexagon end of the bowl allows for easy maintenance by using a simple hexagon wrench.

**CLOGGING INDICATOR**

For further technical informations and other options see page 182-183.



Differential

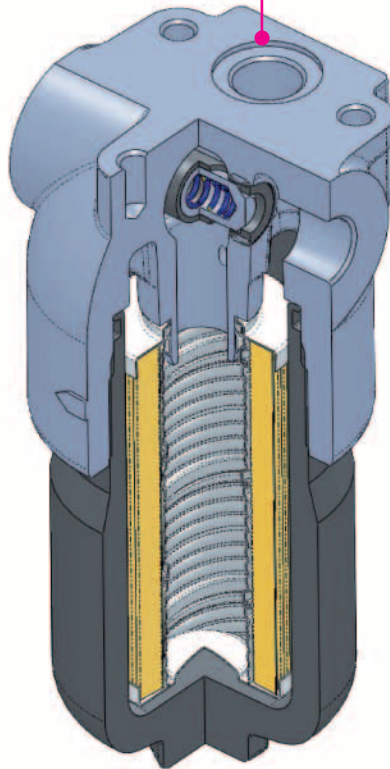

**SPARE SEAL KIT**

	NBR	FKM
FPC21	521.0003.2	521.0030.2
FPC22	521.0003.2	521.0030.2

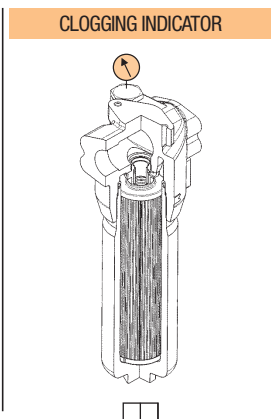
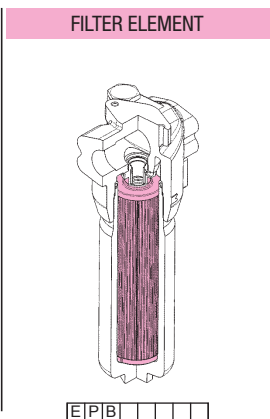
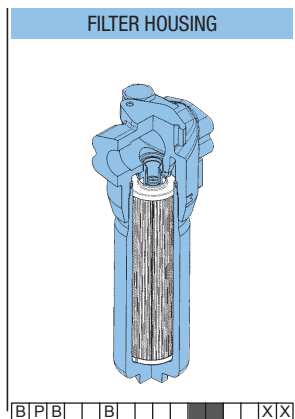

**SPARE PARTS ELEMENTS**  
(For filling up see table "Ordering and option chart")



Is this datasheet the latest release? Please check on our website.

