

E*P4

PILOT OPERATED DISTRIBUTOR SOLENOID OR HYDRAULIC (C*P4) CONTROLLED

E4P4 CETOP P05
E4R4 ISO 4401-05 (CETOP R05)
E5 ISO 4401-08 (CETOP 08)

p max (see table of performances)
Q max (see table of performances)

OPERATING PRINCIPLE

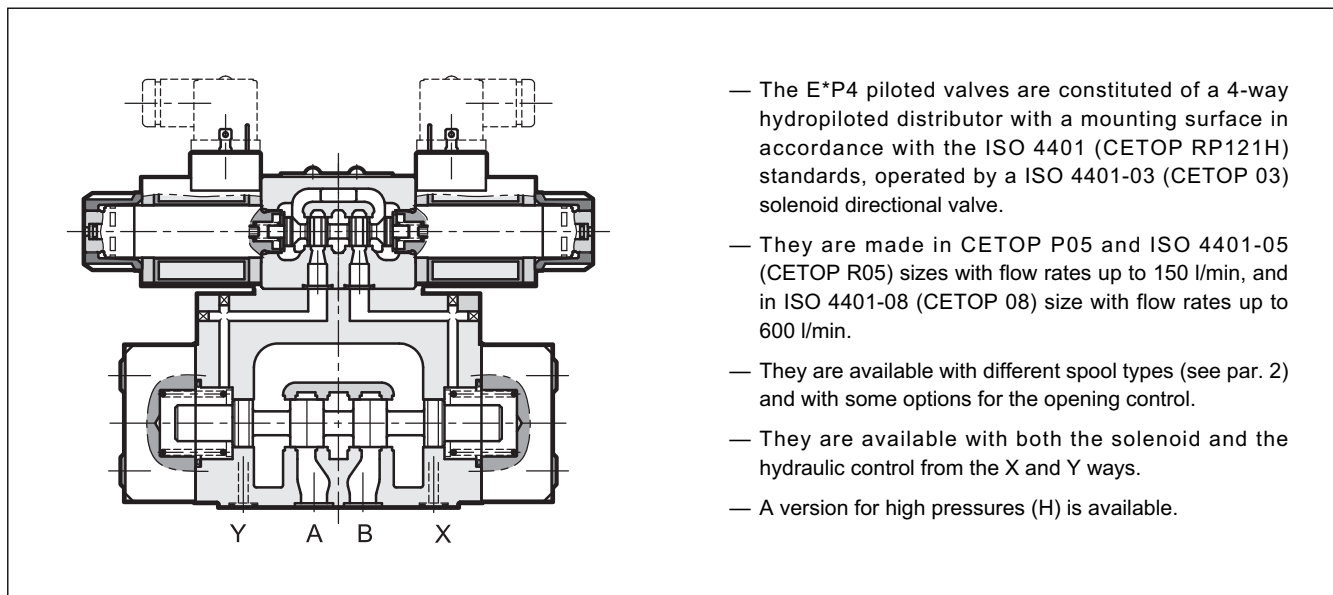

- The E*P4 piloted valves are constituted of a 4-way hydropiloted distributor with a mounting surface in accordance with the ISO 4401 (CETOP RP121H) standards, operated by a ISO 4401-03 (CETOP 03) solenoid directional valve.
- They are made in CETOP P05 and ISO 4401-05 (CETOP R05) sizes with flow rates up to 150 l/min, and in ISO 4401-08 (CETOP 08) size with flow rates up to 600 l/min.
- They are available with different spool types (see par. 2) and with some options for the opening control.
- They are available with both the solenoid and the hydraulic control from the X and Y ways.
- A version for high pressures (H) is available.

PERFORMANCES (obtained with mineral oil of viscosity of 36 cSt at 50°C)

		E4*4	E4HP4	E5P4	E5HP4
Maximum operating pressure	- ports P - A - B	320	420	280	420
	- port T (external drainage)	210	350	210	350
	- port T (internal drainage)	140	140	140	140
Maximum flow rate from port P to A - B - T	l/min	150		600	
Ambient temperature range	°C	-20 / +50			
Fluid temperature range	°C	-20 / +80			
Fluid viscosity range	cSt	10 + 400			
Fluid contamination degree		according to ISO 4406:1999 class 20/18/15			
Recommended viscosity	cSt	25			
Mass: E*P4-S, RK E*P4-TA/TC	kg	7	15,6		
		6,4	15,0		

1 - IDENTIFICATION CODE FOR SOLENOID CONTROLLED DISTRIBUTOR

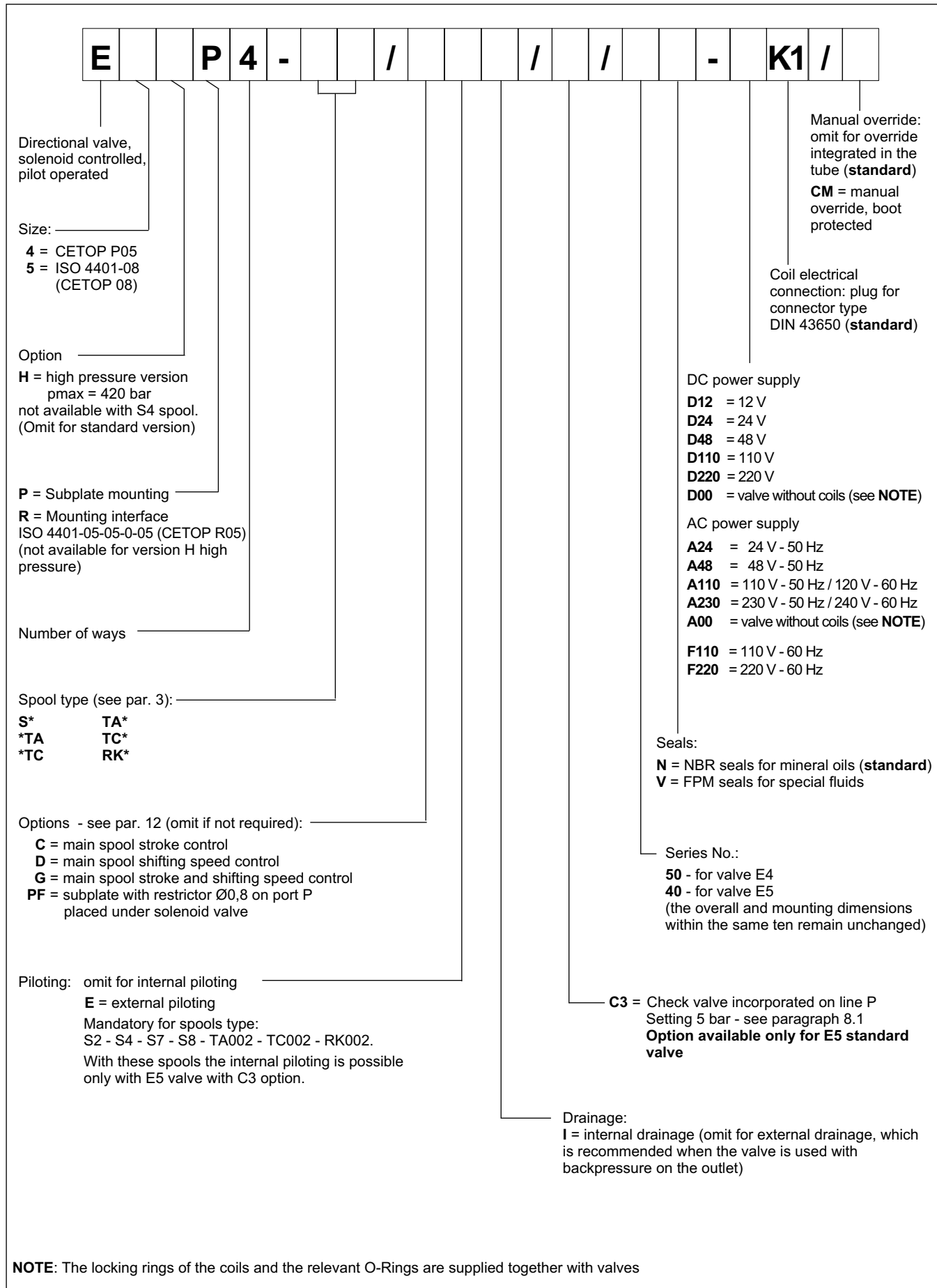

2 - SPOOL TYPE

Symbols are referred to the solenoid valve E*. For the hydraulic control version C* please verify the connection scheme (see par. 4).

Type S:

3 positions with spring centering

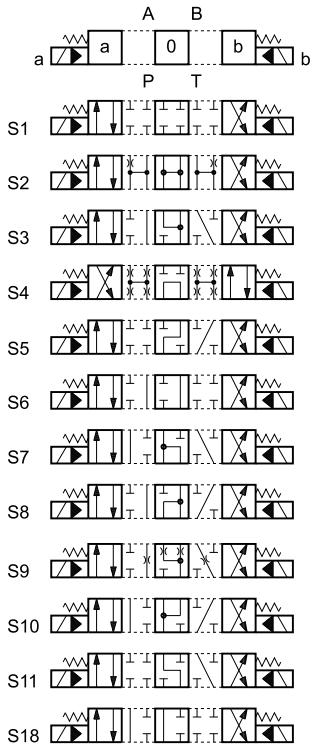

Type *TA:

2 positions (central + external) with spring centering

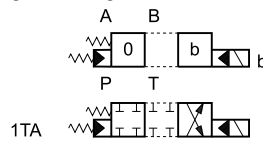

Type TA:

2 external positions with return spring

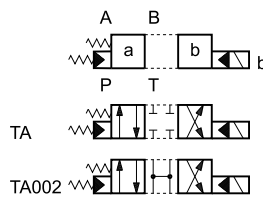

Type 23 (TA/TC):

3-way, 2 external positions with return spring

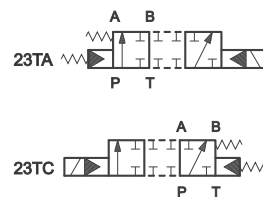

Type *TC:

2 positions (central + external) with spring centering

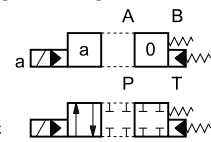

Type TC:

2 external positions with return spring

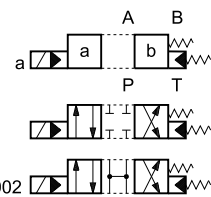

Type RK:

2 positions with mechanical detent on pilot valve

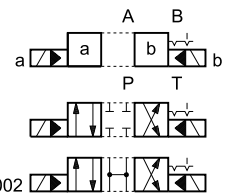

Besides the diagrams shown, which are the most frequently used, other special versions are available: consult our technical department for their identification, feasibility and operating limits.

3 - IDENTIFICATION CODE FOR HYDRAULIC CONTROLLED DISTRIBUTOR C*P4

C			P	4	-			/	E	/		
----------	--	--	----------	----------	----------	--	--	----------	----------	----------	--	--

Hydraulic operated directional valve through X and Y lines

Size: _____
4 = CETOP P05
5 = ISO 4401-08 (CETOP 08)

Option (Omit for standard version) _____
H = high pressure version p_{max} = 420 bar
not available with S4 spool.

Mounting: _____
P = Subplate mounting
R = Mounting interface ISO 4401-05-05-0-05
(CETOP R05) only for C4 standard valve.

Number of ways _____

Spool type (see paragraph 2) _____
S* **TA***
TA** **TC
***TC**

Spool type
The distributor is delivered with short-circuit subplate. The X and Y ports are used for the hydraulic control of the valve.

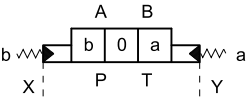

C*P4-S*

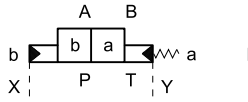

C*P4-TA

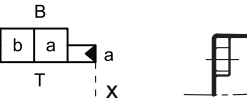

C*P4-TC

Seals:
omit for mineral oils (**standard**)
V = FPM seals for special fluids

Series No.:
43 - for valve C4
34 - for valve C5
(the overall and mounting dimensions within the same ten remain unchanged)

External piloting
External drainage
(see paragraph 8)

Overall dimensions

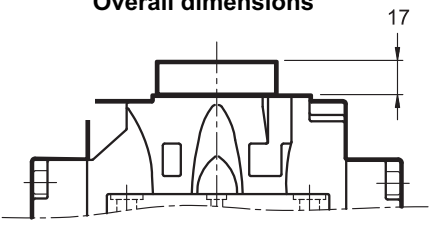

4 - HYDRAULIC FLUIDS

Use mineral oil-based hydraulic fluids HL or HM type, according to ISO 6743-4. For these fluids, use NBR seals (code N for solenoid controlled distributors, omit for hydraulic controlled). For fluids HFDR type (phosphate esters) use FPM seals (code V).

For the use of other kinds of fluid such as HFA, HFB, HFC, please consult our technical department. Using fluids at temperatures higher than 80 °C causes a faster degradation of the fluid and of the seals characteristics.

The fluid must be preserved in its physical and chemical characteristics.

5 - PRESSURE DROPS Δp -Q (values obtained with viscosity 36 cSt at 50 °C)

5.1 - Pressure drops E4P4

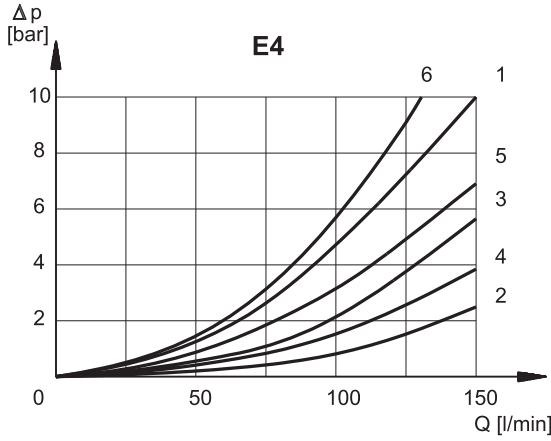

SPOOL TYPE	SPOOL POSITION	E4				
		CONNECTIONS				
		P → A	P → B	A → T	B → T	P → T
CURVES ON GRAPH						
S1	Energized	1	1	2	3	
S2	De-energized Energized	5	5	2	4	6*
S3	De-energized Energized	1	1	1° 2	1° 4	
S4	De-energized Energized	6	6	3	5	6
S5	De-energized Energized	1	1 5	2	3	
S6	De-energized Energized	1	1	2	1 4	
S7	De-energized Energized	6	6	3	5	6°
S8	De-energized Energized	6	6	3	5	6°
S9	Energized	1	1	2	2	
S10	De-energized Energized	1° 5	1° 5	2	3	
S11	De-energized Energized	1	1	1 2	3	
S18	De-energized Energized	5 5	1	2	3	
TA	De-energized Energized	1	1	4	3	
RK	Energized	1	1	4	3	

* A-B blocked * B blocked ° A blocked

5.2 - Pressure drops E5P4

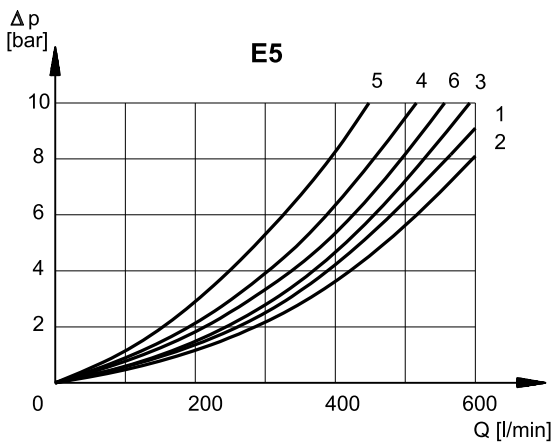

SPOOL TYPE	SPOOL POSITION	E5				
		CONNECTIONS				
		P → A	P → B	A → T	B → T	P → T
CURVES ON GRAPH						
S1	Energized	1	1	2	3	
S2	De-energized Energized	2	2	1	2	6*
S3	De-energized Energized	1	1	4° 1	4° 2	
S4	De-energized Energized	6	6	3	4	5
S5	De-energized Energized	1	4 2	2	3	
S6	De-energized Energized	1	1	2	4 2	
S7	De-energized Energized	6	6	3	4	5°
S8	De-energized Energized	6	6	4	3	5°
S9	Energized	1	1	2	3	
S10	De-energized Energized	4° 2	4° 2	2	3	
S11	De-energized Energized	1	1	3 1	3	
S18	De-energized Energized	4 2	1	2	3	
TA	De-energized Energized	1	1	2	3	
RK	Energized	1	1	2	3	

* A-B blocked * B blocked ° A blocked

6 - SWITCHING TIMES

6.1 Switching times E4P4

The values indicated refer to a solenoid valve working with piloting pressure of 100 bar, with mineral oil at a temperature of 50°C, at viscosity of 36 cSt and with PA and BT connections.

The energizing and de-energizing times are obtained at the pressure variation which occurs on the lines.

E4				
TIMES (± 10%) [ms]	ENERGIZED		DE-ENERGIZED	
	2 Pos.	3 Pos.	2 Pos.	3 Pos.
CA solenoid	35	25	35	25
DC solenoid	60	50	50	40

6.2 Switching times E5P4

The values indicated refer to a solenoid valve working with piloting pressure of 100 bar, with mineral oil at a temperature of 50°C, at viscosity of 36 cSt and with PA and BT connections.

The energizing and de-energizing times are obtained at the pressure variation which occurs on the lines.

E5				
TIMES (± 10%) [ms]	ENERGIZED		DE-ENERGIZED	
	2 Pos.	3 Pos.	2 Pos.	3 Pos.
CA solenoid	70	40	70	40
DC solenoid	100	70	80	50

7 - PERFORMANCE CHARACTERISTICS

E4 - PRESSURES [bar]		E4*4	E4HP4	C4*4	C4HP4
	MIN	MAX			
Pressure in P, A, B ports		320	420	320	420
Piloting pressure (X port and / or Y port)	5	210	350	210	350
Pressure in T line with internal drainage	-	140	140	-	-
Pressure in T line with external drainage	-	210	350	210	350

E5 - PRESSURES [bar]		E5P4	E5HP4	C5P4	C5HP4
	MIN	MAX			
Pressure in P, A, B ports		280	420	280	420
Piloting pressure (X port and / or Y port)	5	210	350	210	350
Pressure in T line with internal drainage	-	140	140	-	-
Pressure in T line with external drainage	-	210	350	210	350

MAXIMUM FLOW RATES [l/min]	E4		E5	
	PRESSURES			
Spool type	at 210 bar	at 320 bar	at 210 bar	at 280 bar
S4, S7, S8	120	100	500	450
All other spools	150	120	600	500

8 - PILOTING AND DRAINAGE

The E*P4 valves are available with piloting and drainage, both internal and external.
The version with external drainage allows for a higher back pressure on the outlet.

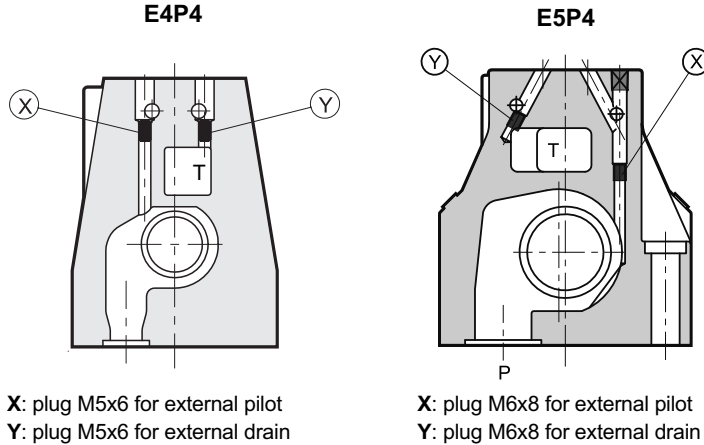

TYPE OF VALVE		Plug assembly	
		X	Y
E*P4-**	INTERNAL PILOT AND EXTERNAL DRAIN	NO	YES
E*P4-**/I	INTERNAL PILOT AND INTERNAL DRAIN	NO	NO
E*P4-**/E	EXTERNAL PILOT AND EXTERNAL DRAIN	YES	YES
E*P4-**/EI	EXTERNAL PILOT AND INTERNAL DRAIN	YES	NO

8.1 - Backpressure valve incorporated on line P available for E5 valve only

Valve E5 is available upon request with backpressure valve incorporated on line P. This is necessary to obtain the piloting pressure when the control valve, in the rest position, has the line P connected to the T outlet (spools S2 - S4 - S7 - S8 - TA002 - TC002 - RK002). The cracking pressure is of 5 bar.

Add **C3** to the identification code for this request (see paragraph 1). **In the C3 version the piloting is always internal.**

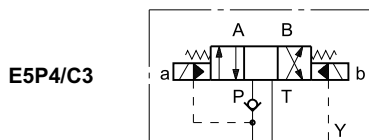

E5P4 (with C3 option)

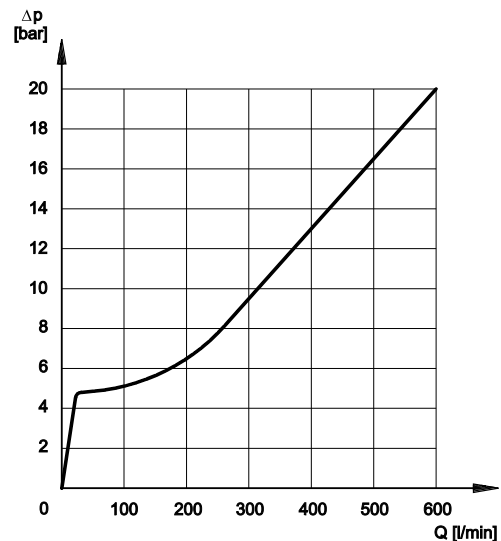
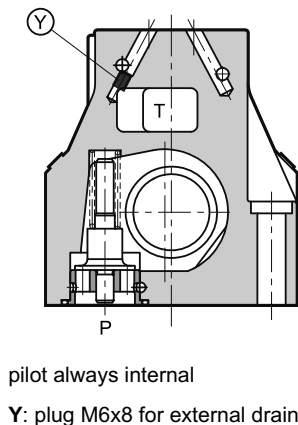

NOTE: the backpressure valve can't be used as direct check valve because it doesn't assure the seal.

The curve refers to the pressure drop (body part only) with backpressure valve energized to which the pressure drop of the reference spool must be added. (see paragraph 5)



9 - ELECTRICAL FEATURES

9.1 Solenoids

These are essentially made up of two parts: tube and coil. The tube is threaded into the valve body and includes the armature that moves immersed in oil, without wear. The inner part, in contact with the oil in the return line, ensures heat dissipation.

The coil is fastened to the tube by a threaded ring, and can be rotated 360°, to suit the available space.

NOTE 1: In order to further reduce the emissions, use of type H connectors is recommended. These prevent voltage peaks on opening of the coil supply electrical circuit (see catalogue. 49 000).

NOTE 2: The IP65 protection degree is guaranteed only with the connector correctly connected and installed.

VOLTAGE SUPPLY FLUCTUATION	±10% Vnom
MAX SWITCH ON FREQUENCY E4 E5	10.000 ins/hr 8.000 ins/hr
DUTY CYCLE	100%
ELECTROMAGNETIC COMPATIBILITY (EMC) (NOTE 1)	According to 2004/108/CE
LOW VOLTAGE	According to 2006/95/CE
CLASS OF PROTECTION: Atmospheric agents (CEI EN 60529) Coil insulation (VDE 0580) Impregnation: DC valve AC valve	IP 65 (NOTE 2) class H class F class H

9.2 Current and absorbed power for DC solenoid valve

The table shows current and power consumption values relevant to the different coil types for DC.

The rectified current supply takes place by fitting the valve (with the exception of D12 coil) with an alternating current source (50 or 60 Hz), rectified by means of a bridge built-in to the "D" type connectors (see cat. 49 000), by considering a reduction of the operating limits by 5 ÷ 10% approx.

Coils for direct current (values ± 5%)

Suffix	Nominal voltage [V]	Resistance at 20°C [ohm]	Current consumpt. [A]	Power consumpt. [W]	Coil code
D12	12	4,4	2,72	32,7	1903080
D24	24	18,6	1,29	31	1903081
D48	48	78,6	0,61	29,5	1903083
D110	110	423	0,26	28,2	1903084
D220	220	1692	0,13	28,2	1903085

9.3 Current and absorbed power for AC solenoid valve

The table shows current and power consumption values at inrush and at holding, relevant to the different coil types for AC current.

Coils for alternating current (values ± 5%)

Suffix	Nominal voltage [V]	Frequency [Hz]	Resistance at 20°C [Ω]	Current consumption at inrush [A]	Current consumption at holding [A]	Power consumption at inrush [VA]	Power consumption at holding [VA]	Coil code
A24	24	50	1,46	8	2	192	48	1902830
A48	48	50	5,84	4,4	1,1	204	51	1902831
A110	110V-50Hz 120V-60Hz	50/60	32	1,84	0,46	192	48	1902832
				1,56	0,39	188	47	
A230	230V-50Hz 240V-60Hz		140	0,76	0,19	176	44	1902833
				0,6	0,15	144	36	
F110	110	60	26	1,6	0,4	176	44	1902834
F220	220		106	0,8	0,2	180	45	1902835

10 - E4 OVERALL AND MOUNTING DIMENSIONS

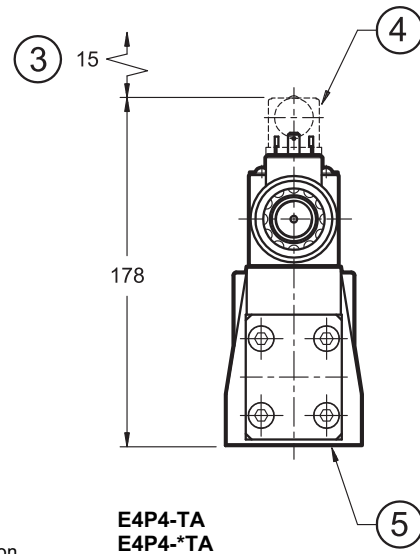
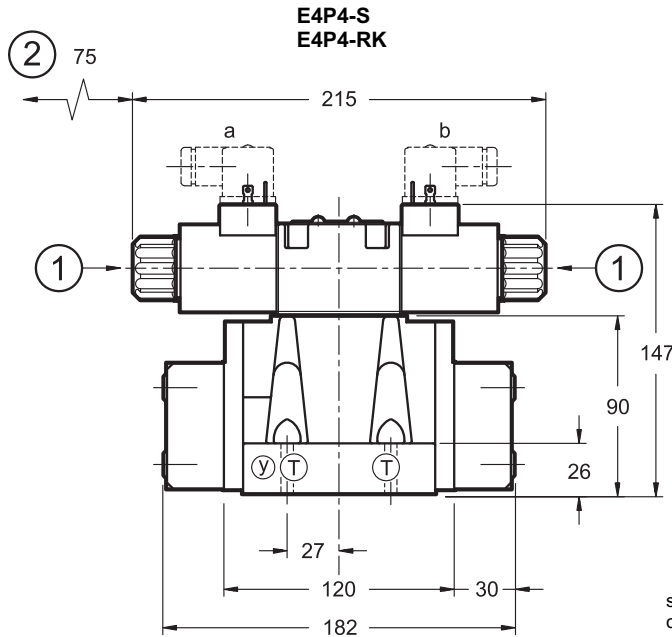

solenoid position configuration TC/*TC

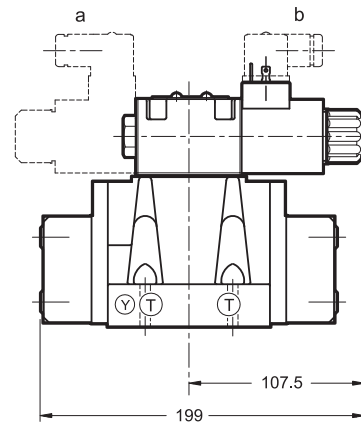
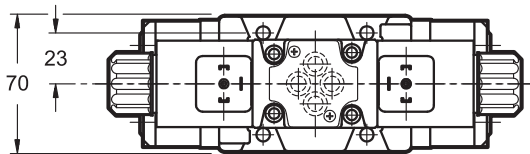

MOUNTING SURFACE (STANDARD)

CETOP 4.2-4 P05-320

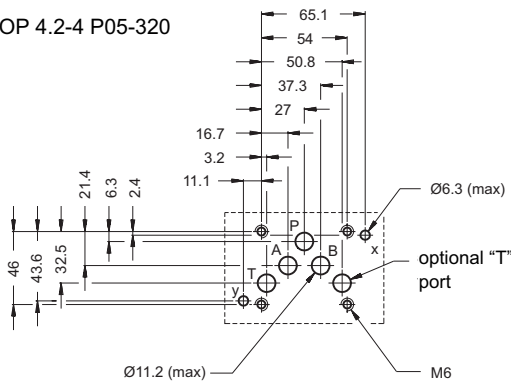

Valves with ISO 4401-05-05-0-05 (CETOP R05) mounting interface are available upon request. See par. 1 for their identification.

ISO 4401-05-05-0-05
CETOP 4.2-4 R05-320

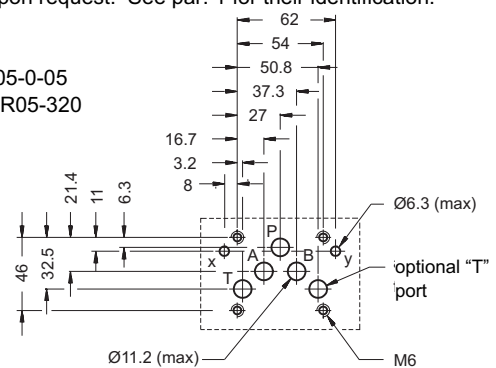

dimensions in mm

Fastening of single valve: 4 bolts M6x35 (see par. 15, NOTE)	1	Manual override
Tightening torque: 8 Nm (bolts A 8.8) 14 Nm (bolts A 12.9)	2	Coil removal space
Threads of mounting holes: M6x10	3	Connector removal space
Sealing rings: 5 OR type 2050 (12.42x1.78) - 90 Shore 2 OR type 2037 (9.25x1.78) - 90 Shore	4	Electric connector to be ordered separately (see cat.49 000)
	5	Mounting surface with sealing rings

12 - OPTIONS

12.1 Control of the main spool stroke: C

It is possible to introduce special stroke controls in the heads of the hydropiloted valve so as to vary the maximum spool clearance opening.

This solution allows control of the flow rate from the pump to the actuator and from the actuator to the outlet, obtaining a double adjustable control on the actuator.

Add the letter **C** to the identification code to request this device (see paragraph 1).

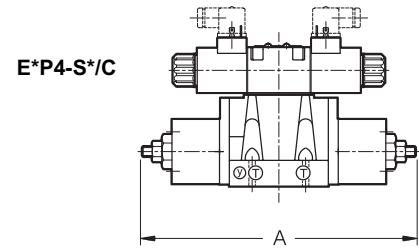

12.2 Control of the main spool shifting speed: D

By placing a MERS type double flow control valve between the pilot solenoid valve and the hydropiloted valve, the piloted flow rate can be controlled and therefore the changeover smoothness can be varied.

Add the letter **D** to the identification code to request this device (see paragraph 1).

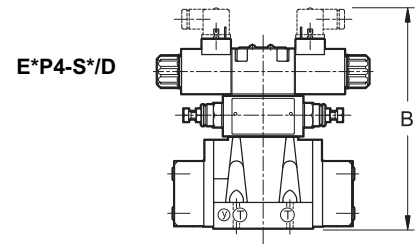

12.3 Subplate with throttle on line P

It is possible to introduce a subplate with a restrictor of Ø0,8 on line P between the pilot solenoid valve and the main distributor.

Add **PF** to the identification code to request this option (see paragraph 1).

12.4 Control of the main spool stroke and shifting speed: G

It is possible to have the valve fitted with both the spool stroke device and the piloting flow rate control device.

Add the letter **G** to the identification code to request this solution (see paragraph 1).

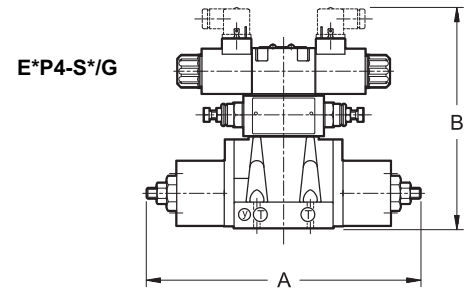

dimensions in mm

	E4	E5
A	280	401,5
C	218	254

13 - MANUAL OVERRIDE, BOOT PROTECTED: CM

Whenever the solenoid valve installation may involve exposure to atmospheric agents or use in tropical climates, the manual override, boot protection is recommended.

Add the suffix **CM** to request this device (see paragraph 1).

For overall dimensions see cat. 41 150.

14 - ELECTRIC CONNECTORS

The solenoid valves are never supplied with connector. Connectors must be ordered separately.

To identify the connector type to be ordered, please see catalogue 49 000.

15 - INSTALLATION

Configurations with centering and recall springs can be mounted in any position; type RK valves - without springs and with mechanical detent - must be mounted with the longitudinal axis horizontal.

Valve fastening takes place by means of screws or tie rods, laying the valve on a lapped surface, with values of planarity and smoothness that are equal to or better than those indicated in the drawing. If the minimum values of planarity or smoothness are not met, fluid leakages between valve and mounting surface can easily occur.

NOTE: Use of class 12.9 fastening screws is recommended for valves in version H (high pressure).

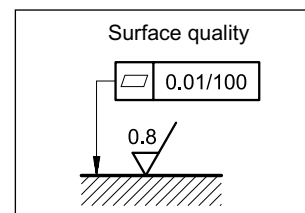

16 - SUBPLATES (see catalogue 51 000)

These plates are for the standard valves only. They are not suitable for high pressure (H) versions.

	E4	E5
Type with rear ports	PME4-AI5G	
Type with side ports	PME4-AL5G	PME5-AL8G
P, T, A, B, port dimensions	3/4"	1½" BSP
X, Y port dimensions	1/4" BSP	1/4" BSP