

GRIEGER

Hydraulik

Hydraulics

Zwischenplatten-Rückschlagventile,
entsperrbar

Modular Check Valves,
pilot operated

NG 10



Ausgabe
Version 04.08

Bestnr.
Order codes 101 020 ...

5.7.1.2

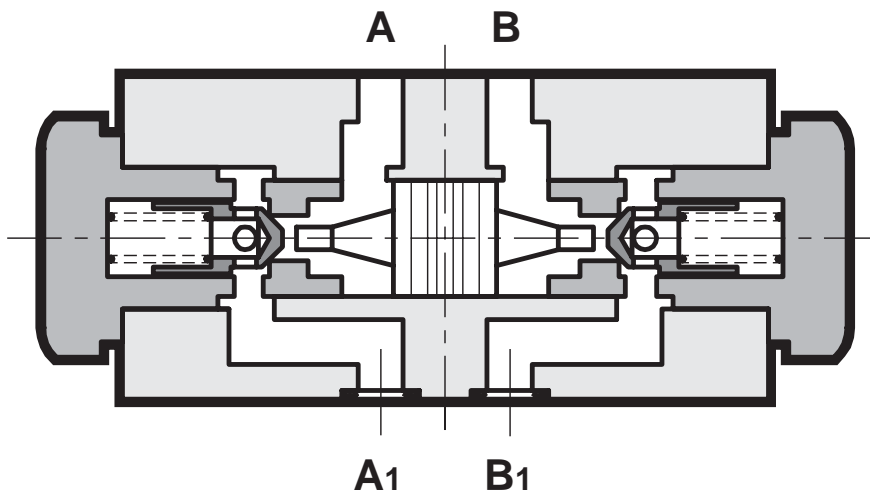

1. 320 bar-Version

1. 320 bar version

2. bis zu 65 l/min

2. up to 65 l/min

3. Sitzventil

3. seat valve

4. Flächenverhältnis 5,8:1

4. area ratio 5.8:1

5. 3 bar-Rückschlagventile

5. 3 bar check valves

6. Standardhöhe 50mm

6. standard height 50 mm

Inhalt	Seite
Typen/Bestellnummern	4
Kenngrößen	5
$\Delta p/Q$ -Kennlinien	6
Abmessungen	7
Ersatzteile	7

Contents	Page
Types/Order codes	4
Specifications	5
$\Delta p/Q$ -Curves	6
Dimensions	7
Spare parts	7

Typen, Bestellnummern Types, order codes

Bestellnr. / Order code 101 020 ...

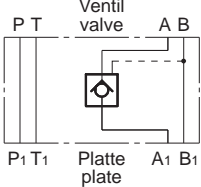
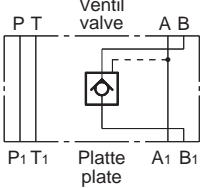
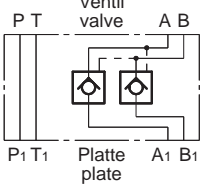
Nr.	Symbol	
1	 <p>Ventil valve A B P T P1 T1 Platte plate A1 B1</p>	001
2	 <p>Ventil valve A B P T P1 T1 Platte plate A1 B1</p>	002
3	 <p>Ventil valve A B P T P1 T1 Platte plate A1 B1</p>	003

Kenngrößen	Specifications	
Allgemein	General	
Sitzventil	Seat valve	
Plattenanschluss	Subplate mounted	NG 10 - ISO 4401 / CETOP 05
Umgebungstemperatur	Ambient temperature	-20 °C to +50 °C
Gewicht:	Weight:	
Symbol 1, 2	Symbol 1, 2	2.9 kg
Symbol 3	Symbol 3	3.1 kg
Hydraulisch	Hydraulic	
für Hydrauliköle auf Mineralölbasis Type HL oder HM nach (andere Medien auf Anfrage)	for mineral oil based hydraulic fluids HL or HM type according to (other fluids on request)	ISO 6743-4
Viskositätsbereich	Viscosity range	10 - 400 cSt
empfohlene Viskosität	recommended viscosity	25 cSt
Zulässige Ölverschmutzungs-klasse	Fluid contamination degree	ISO 4406: 1999, Klasse / class 20/18/15
NBR-Dichtungen Standard FPM-Dichtungen auf Anfrage	NBR seals standard FPM seals on request	
Druckmitteltemperaturbereich	Fluid temperature range	-20 °C to +80 °C
Betriebsdruck	Operating pressure	max. 320 bar
Nenn-durchfluss siehe S. 6	Rated flow see page 6	
Maximaler Durchfluss Ventil	Maximum flow valve	65 l/min
Max. Durchfluss freie Leitungen	Max. flow free lines	100 l/min
Flächenverhältnis	Area ratio	5.8:1
Öffnungsdruck des Rückschlagventils	Check valve Cracking pressure	3 bar

$\Delta p/Q$ -Kennlinien
 $\Delta p/Q$ -Curves

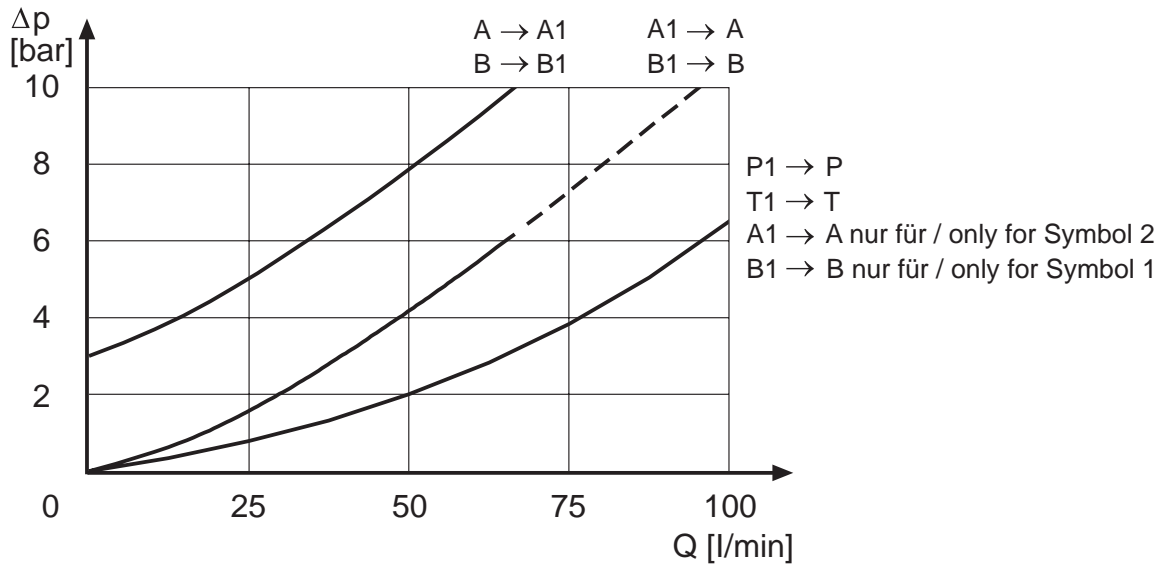

Lochbild
Mounting interface
CETOP 4.2-4-05-320
ISO/CD 4401-05

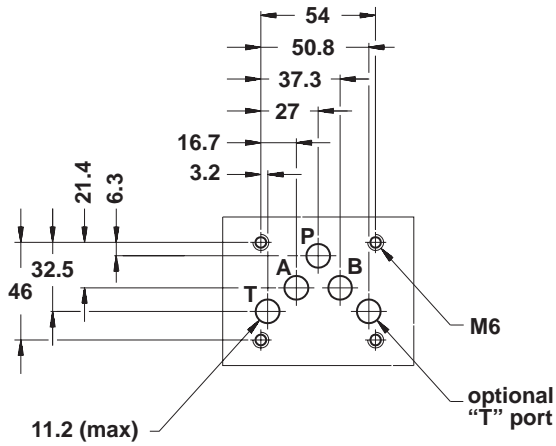

Abmessungen
Dimensions

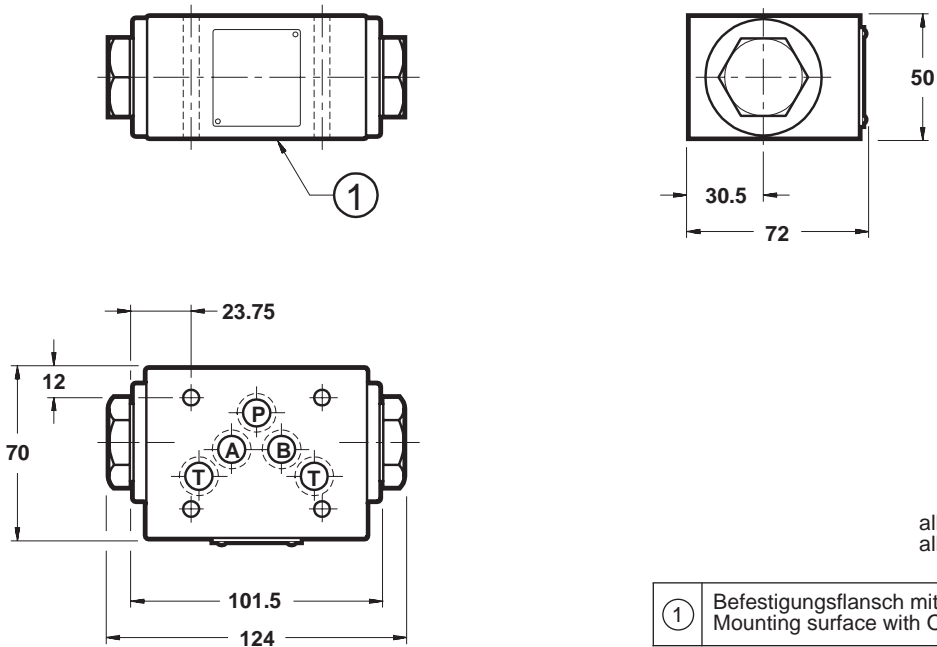

alle Maßangaben in mm
 all dimensions are in mm

①	Befestigungsflansch mit O-Ringen Mounting surface with O-rings
---	---

Ersatzteile
Spare parts

Bestellnr. / Order code 101 022 ...

Dichtungssatz NBR Seal Kit NBR	5 x O-Ring 2050 - 90 shore	005
Dichtungssatz FPM/Viton Seal Kit FPM/Viton	5 x O-Ring 2050 - 90 shore	006

www.grieger-automation.com

Grieger
Saarstr. 41
71282 Hemmingen
Germany

Tel: +49 7150 301 501
Fax: +49 7150 301 502

Grieger Asia Pte Ltd
2 Jurong East Street 21
#03-152, IMM Building
Singapore 609601

Tel: +65 6425 6562
Fax: +65 6425 6755

Hydraulik Produktpalette

- Wegeventile NG 6, 10, 16, 25, 32
- Proportionalventil NG 6, 10, 16, 25
- Verstärker für Proportionalventile
- Modularventile NG 6, 10, 16
- Druckventile NG 6, 10, 16, 25 und Rohrleitungseinbau
- DIN-Einbauventile NG 10, 16, 25, 32, 40, 50, 63
- Anschlussplatten NG 6, 10, 16, 25, 32
- Zahnradpumpen Größe 2, 4-30 cm³/U
- Kugelhähne
- Drosselventile
- Rückschlagventile

Hydraulic product range

- Directional control valves NG 6, 10, 16, 25, 32
- Proportional valves NG 6, 10, 16, 25
- Amplifiers for proportional valves
- Modular valves NG 6, 10, 16
- Pressure valves NG 6, 10, 16, 25 and inline mounting
- DIN cartridge valves NG 10, 16, 25, 32, 40, 50, 63
- Subplates NG 6, 10, 16, 25, 32
- Gear pumps size 2, 4-30 ccm/rev
- Ball valves
- Needle valves
- Check valves

Ihr Vertragspartner
Your authorized distributor